

Operating Instructions

# Sartorius Moisture Analyzer

Model MA37  
Electronic Moisture Analyzer



# Contents

<b>User Information</b> .....	3	<b>MA Performance Test</b> .....	39
<b>Safety Information</b> .....	4	Starting the Performance Test .....	39
<b>General View of the Equipment</b> .....	7	Performance Test Measurement Not Successfully Completed .....	41
<b>Startup</b> .....	8	Performance Test Successfully Completed .....	41
<b>Transporting the Analyzer</b> .....	12	<b>Calibration and Adjustment</b> .....	42
<b>Basic Principles</b> .....	13	Viewing the Calibration Report .....	44
<b>Operating the Moisture Analyzer</b> .....	20	Weighing .....	45
Switching the Analyzer On and Off (Standby) .....	20	<b>ISO/GLP-compliant Printout</b> .....	46
Setting the Language .....	21	<b>USB Interface</b> .....	48
Operating Concept .....	22	Communication with Peripheral Devices .....	48
Menu .....	23	Interface Specification .....	51
Entering Numbers on the Number Pad .....	24	<b>Error Messages</b> .....	53
Entering Text and Characters .....	24	<b>Shipping the Analyzer</b> .....	55
Scrolling in the Display .....	25	<b>Care and Maintenance</b> .....	57
<b>System Settings (Setup Menu)</b> .....	26	<b>Disposal</b> .....	61
Opening the Menu and Changing the Settings .....	26	<b>Specifications</b> .....	62
List of Available Settings .....	27	<b>Accessories</b> .....	63
<b>Moisture Analysis</b> .....	33	<b>Analyzer Dimensions</b> .....	64
Viewing and Changing Method Parameters .....	33	<b>Declaration of Conformity</b> .....	65
Performing the Moisture Analysis .....	35	<b>Certificate of Compliance</b> .....	66

# User Information

## Warning/Danger Symbols Used in these Instructions:



These notes identify hazards which have a high probability of resulting in death or serious physical injury if not avoided.



These notes identify hazards that can result in moderate or mild injuries if not avoided.



These notes identify hazards associated with the risk of material damage.

## Explanation of Symbols

The following symbols are used in this manual:



Useful information and tips



Hot surface: Warning – Risk of severe burns!



Note regarding device operation



When individual buttons are displayed, they should be pressed.

The following symbols are used in these instructions:

- ▶ Indicates a required action
- ▷ Describes what happens after you have performed a particular step

Perform steps in the specified order:

1. First action
  2. Second action
  3. ...
- Indicates an item in a list

## Application Advice/Technical Support

Addresses for applications advice and technical support can be found on the website at: <http://www.sartorius.com>

# Safety Information

## Guidelines and General Information

- The analyzer complies with EU Directives and standards, among other regulations, for electrical safety and electromagnetic compatibility\*. Improper use or handling can, however, result in damage to objects and injury. Any improper use or operation of the analyzer that is not consistent with the instructions will result in forfeiture of all claims under the manufacturer's warranty.
- Personnel need to have read and understood these installation instructions, including the safety instructions.
- In the event of use in systems and ambient conditions which have greater safety requirements, you must observe the requirements and provisions applicable in your country.
- Always keep the equipment and analyzer freely accessible. Any improper installation of the analyzer that is not consistent with the instructions will result in forfeiture of all claims under the manufacturer's warranty.

\* = see "Specifications"



### Danger of Explosion!

The analyzer must not be operated in potentially explosive atmospheres. Materials liable to catch fire or explode may not be used as samples for moisture analysis.



Before initial startup, ensure that the voltage rating printed on the manufacturer's ID label of the analyzer matches the voltage of the local AC power.

## Installation Instructions



Danger of severe personal injury or property damage due to faulty analyzer components! Do not operate the analyzer if the housing or power supply cable, including any connections, is damaged. Immediately disconnect the damaged analyzer from the power by pulling the plug.



### Danger of Electric Shock!

The analyzer has a power supply cable with a protective grounding conductor. Only standard-compliant extension cords with protective grounding conductors are permitted for use with the analyzer.



Do not expose the analyzer, its power supply cable, or accessories supplied by Sartorius to extreme temperatures, aggressive chemical vapors, moisture, shock, vibrations, or strong electromagnetic fields. Observe the conditions of operation described in the Specifications.



The operator shall be solely responsible for any modifications to the equipment and for connecting any cables or equipment not supplied by Sartorius. Information on operational quality is available upon request from Sartorius. Only use original Sartorius accessories!



Note the IP protection class of the analyzer! Do not allow liquid penetration. The protection class specifies the suitability of equipment for various environmental conditions (moisture, foreign bodies).



Before cleaning the analyzer: Unplug the power supply cable from the socket.



Position the power cable so that it cannot touch the hot surfaces of the analyzer and is not a trip hazard. Disconnecting the grounding conductor is prohibited.

The device may only be opened by specialized personnel trained by Sartorius.

### Danger due to Fire or Explosion!



- Flammable or explosive substances
  - Substances containing solvents
  - Substances that release flammable or explosive gases or vapors during the drying process: When working with these types of samples, use a drying temperature that is low enough to prevent a fire or explosion from occurring.
  - If in doubt, carry out a careful risk analysis.
  - Wear safety glasses.
  - Always work with small sample quantities.
- Never leave the analyzer unattended in these cases.**



No modifications are permitted to the analyzer.

### Symbols Used on the Device



When setting up the moisture analyzer, leave enough space to prevent heat from building up and to keep the analyzer from overheating:

- 1 m above the analyzer
- 20 cm around the analyzer

The vent above the sample must not be covered or modified in any other way. During operation do not open the hood, because the heating unit may be very hot.

Do not put any flammable substances on, under, or near the analyzer because the area around the heating unit will heat up.

Be careful when removing the sample: The sample itself, the heating unit, and the sample pans may still be extremely hot.

Observe the additional safety and danger information in the following chapters.

### Personal Protective Equipment

When operating the analyzer, suitable protective equipment must be worn in order to minimize dangers to health.

- During work, always wear the protective equipment needed for the task at hand.
- Follow any instructions posted in the work area pertaining to personal protective equipment.

Wear the following personal protective gear during all work:



#### Protective Clothing

Wear a laboratory coat. This lab coat protects the user from hazards due to the dangerous substances or is prescribed for your process.



#### Safety Glasses

Wear safety glasses to protect yourself from liquid spray and splashes, and substances escaping under high pressure.



#### Safety Gloves

Wear suitable safety gloves when handling chemicals or hazardous substances. Check that the gloves are not worn and do not have any holes or tears before putting them on.

---

### Intended Use

The moisture analyzer can be used for quick and reliable determination of the moisture content of materials of liquid, pasty, and solid substances using the thermogravimetric method. Only use the analyzer for this purpose. Any other use outside the limits of the technical specifications is not permitted.

Moisture analysis applications must be optimized by the user in accordance with local regulations.

Appropriate containers must be used for each type of sample material.

All other applications are not considered the intended use. If the equipment is used in a manner not specified by the manufacturer, the protection provided by the equipment may be impaired.

# General View of the Equipment

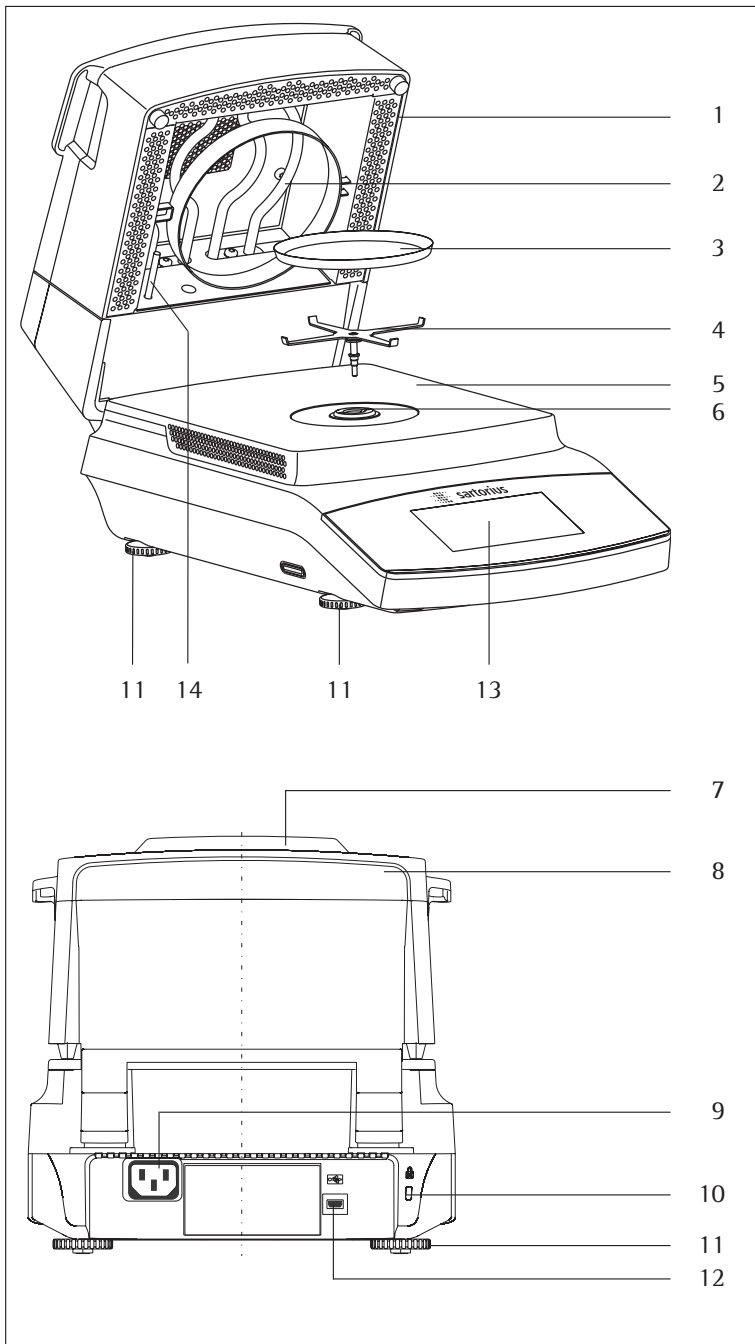

**Item Name and Function**

1	Heating module
2	Heating element
3	Disposable sample pan
4	Pan support
5	Sample chamber bottom
6	Locking socket (bayonet)
7	Process status light
8	Unlocking handle for heating module
9	Power socket for country-specific power cable
10	Fastening point for an optional Kensington key lock
11	Leveling feet
12	USB port for mini AB
13	Display and control unit (touch screen)
14	Temperature sensor

# Startup

## Unpacking and Equipment Supplied

- ▶ Open the packaging, making sure to remove all parts carefully.
- ▶ After unpacking the analyzer, check it immediately for any external damage.
  - If you detect any damage, proceed as directed in “Care and Maintenance.”
- Save the box and all parts of the packaging for any future transport. During shipment, please do not leave cables plugged in!

The following parts are included in the equipment supplied:

- 
- Moisture analyzer
- 
- Country-specific power cable
- 
- Pan support
- 
- Protective cover for the control panel
- 
- 80 disposable aluminum sample pans
- 
- 80 glass-fiber filters
- 
- Operating instructions
- 

## Choosing a Location

### ▶ Select the proper setup location:

An optimal location guarantees accuracy and reliability. Ensure that the following ambient conditions are met:

- Set up the analyzer on a stable, even surface that is not exposed to vibrations (e.g., weighing stone).
- Maintain free access to the analyzer at all times.
- Make sure to choose a place where excessive heat cannot build up.
- Leave enough space between it and materials that are affected by heat.

Choose a location that is not subject to the following negative influences:

- Heat (heater or direct sunlight)
- Drafts from open windows, AC systems, and doors
- Extreme vibrations during measurement
- Heavy traffic areas (personnel)
- Extreme humidity
- Electromagnetic fields

## Acclimatization

Condensation from humidity can form on the surfaces of a cold device when it is brought into a substantially warmer area. You should therefore let a device that has been disconnected from its power source acclimatize for approximately 2 hours before reconnecting it to the power.



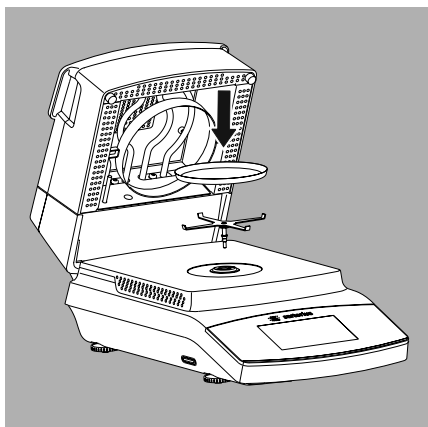

### Setting Up the Analyzer

- ▶ Assemble the parts in the following order:
  - Pan support
  - Disposable sample pan
  - The protective cover over the control panel is pre-assembled at the factory.

### Compensating for Unevenness of the Setup Surface

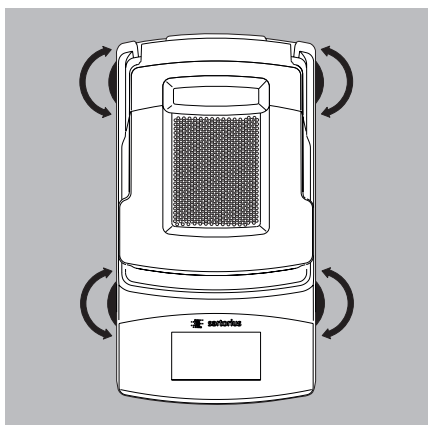

- ▶ Twist the leveling feet until any slight unevenness in the setup surface is rectified and the analyzer is stable.

### Anti-theft Locking Device

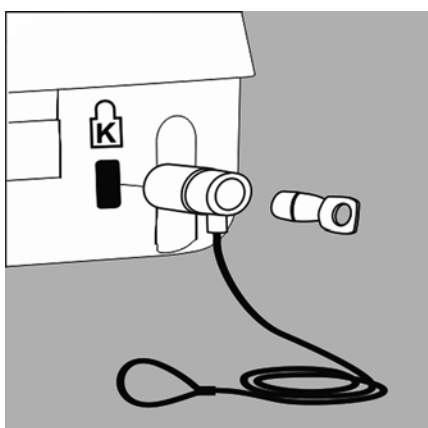

- To protect against theft, the analyzer has a fastening point for a security lock if required.
- ▶ A Kensington key lock can be installed at the fastening point on the back of the analyzer if required.

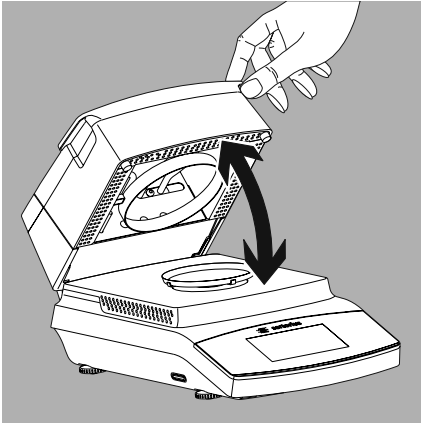

### Opening and Closing the Sample Chamber

- ▶ Open or close the sample chamber by hand. Always open the heating module fully.

### Power Connection (Power Supply)



- Using the wrong power cables may cause fatal electric shock and damage the equipment.
- Never plug the power cable into the socket when it is disconnected from the analyzer (danger of electrical shock).
- Only connect the analyzer to an AC socket with a protective grounding conductor.
- Only standard-compliant extension cords with protective grounding conductors are permitted for use with the analyzer.
- Intentionally disconnecting the analyzer from the protective grounding conductor is not permitted.

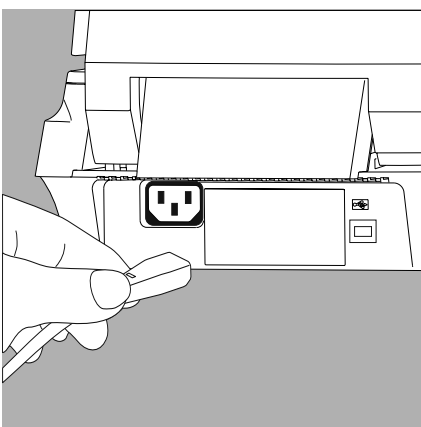

- ▶ Check the plug design of the power cable.  
If the plug design of the power cable does not comply with your country's standard, please inform the nearest Sartorius representative or your dealer. The power must be connected in accordance with the regulations applicable in your country. In order to connect the equipment to the power supply (protection class 1), use a correctly installed wall outlet with a protective grounding conductor (PE) and a fuse of a maximum 16 A. The power plug or another suitable disconnecting device for the power must be easily accessible so that the analyzer can be disconnected from the AC power supply in the event of an emergency.
- ▶ Connect the analyzer to the AC power.
- ▶ Position the cable so that it cannot be damaged or hinder the measurement process.

#### Safety Precautions

If you use an electrical outlet that does not have a protective grounding conductor, ensure that an equivalent protective conductor is installed by a certified electrician (as specified in the applicable regulations for installation in your country). The protective effect must not be negated by using an extension cord without a protective grounding conductor.

### Power Cable Versions

Item No.	Region/Country
69 00900	Europe/EU (except the UK, Denmark, Italy, and Switzerland)
69 00901	USA, Canada, and Japan
69 00902	South Africa
69 00905	Australia, New Zealand
69 71945	UK
69 71972	Brazil
69 71973	India
69 71975	Israel
69 71976	Italy
69 71977	Argentina
69 71978	China
69 71979	Switzerland
69 71980	Denmark

#### Note:

This equipment has been tested and found to comply with the limits for a Class B digital device, pursuant to part 15 of the FCC Rules. These limits are designed to provide reasonable protection against harmful interference in a residential installation. This equipment generates, uses and can radiate radio frequency energy and, if not installed and used in accordance with the instructions, may cause harmful interference to radio communications.

However, there is no guarantee that interference will not occur in a particular installation. If this equipment does cause harmful interference to radio or television reception, which can be determined by turning the equipment off and on, the user is encouraged to try to correct the interference by one or more of the following measures:

- Reorient or relocate the receiving antenna.
- Increase the separation between the equipment and receiver.
- Connect the equipment into an outlet on a circuit different from that to which the receiver
- Consult the dealer or an experienced radio/TV technician for help

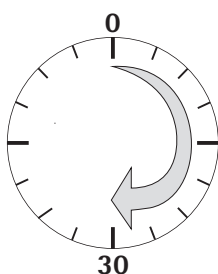

### Warm-up Time

To return precise results, the analyzer must warm up for at least 30 minutes after initial connection to the power supply. Only after this time will the analyzer have reached the required operating temperature.

# Transporting the Analyzer

## Moving the Analyzer in the Lab



Avoid shocks and vibrations:

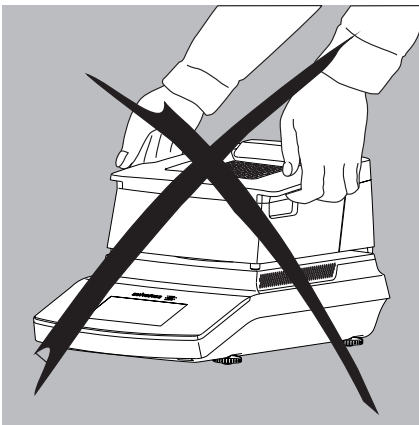

► Never lift and carry the analyzer by its heating module.

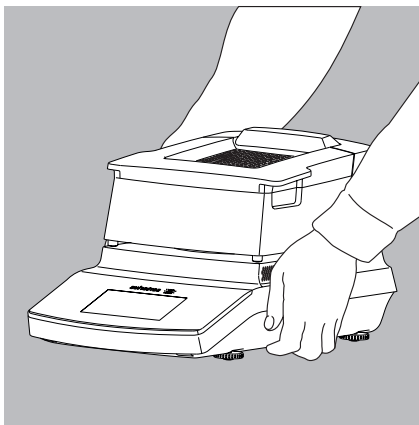

► Hold the analyzer under the housing, lift it up carefully, and carry it to its new location.

# Basic Principles

## Purpose

The moisture analyzer can be used for quick and reliable determination of the moisture content of materials of liquid, pasty, and solid substances using the thermogravimetric method.

## Material

The moisture of a sample is often mistakenly equated to its water content. In fact, the moisture of a material includes all of the volatile components which are emitted when the sample is heated, and lead to a reduction in its weight. Among such volatile substances are:

- Water
- Fats
- Oils
- Alcohols
- Organic solvents
- Flavorings
- Volatile components, products of decomposition (when a sample is overheated)

There are many methods for determining the moisture content of a substance. Basically, these methods can be divided into two categories:

When absolute methods are used, the moisture content is directly determined (for example, as a weight loss registered during the drying routine). These methods include oven drying, infrared drying, and microwave drying. All three of these methods are thermogravimetric.

When deductive methods are used, the moisture content is indirectly determined. A physical property related to the moisture in the substance is measured (e.g., conductivity). These methods include capacitive and spectroscopic processes.

Thermogravimetry is the process of determining the loss of mass that occurs when a substance is heated. In this process, the sample is weighed before and after being heated, and the difference between the two weights is calculated.

In a conventional drying oven, circulating hot air warms the sample from the outside to the inside. Efficiency is lost during drying because as the moisture evaporates, it cools the sample surface.

By contrast, infrared rays (IR rays) penetrate a sample without being impeded. Having reached the interior of a sample, they heat the sample directly.

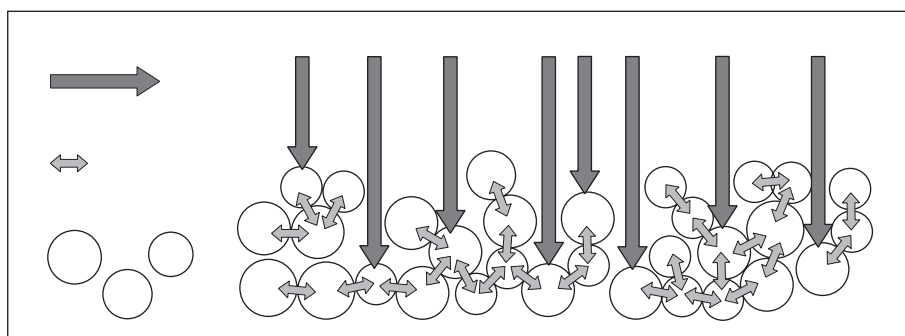

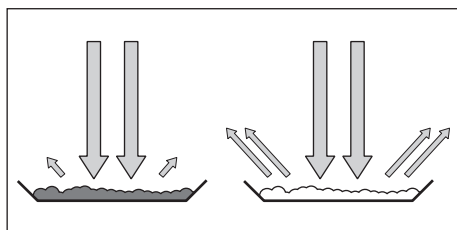

The IR rays that do not heat the sample are either reflected from surface of the sample or absorbed unimpeded into the sample.

The color and surface characteristics of the sample determine how effective the heating process is. For example, dark substances absorb IR rays more effectively than light substances.

How the rays penetrate the sample depends on the permeability of the sample. If the degree of light-transmitting capacity is low, the rays can penetrate only the uppermost layers of the sample. The heat conductivity of the sample dictates the degree to which the heat can be transmitted to the underlying layers. The higher the conductivity, the faster and more uniformly the substance is heated.

The substance should be applied to the sample pan in a thin, even layer. A height of approximately 2–5 mm for 5–15 g substance weight has proved to be ideal. Otherwise, the sample will not be dried completely or the analysis time will be unnecessarily extended, a crust/skin will form on the surface of the sample or the sample will scorch, and the analysis results obtained will not be reproducible (and hence cannot be used).

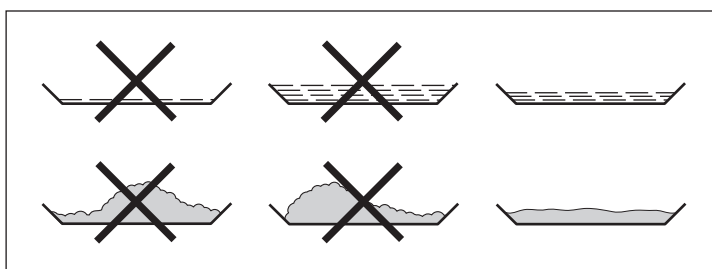

While preparing substances for measurement, no processes may be used that generate heat. The heat generated may result in a loss of moisture prior to the measurement.

Perform initial analysis of a new substance to test how the IR rays are absorbed by the sample and converted into heat. A printout of the intermediate values of the drying process provides information on this at an early stage.

Due to the fact that the supply of IR rays results in intensive energy input into the sample, the temperature setting selected for infrared drying is usually lower than the temperature setting used when working with a drying oven.

In many cases, the fully automatic switch-off mode will meet your requirements. If the final result is higher or lower than expected, try varying the temperature setting before resorting to a different switch-off criterion.

When analyzing the samples that lose their moisture only very slowly or when operating a cold moisture analyzer, the fully automatic mode may end the drying routine too early since no analyzable progress in the drying routine can be detected. In this case, preheat the moisture analyzer for two to three minutes before starting the drying routine, or select a different switch-off criterion.



The Application Guide for the Sartorius Moisture Analyzer provides you with important information on the use of your moisture analyzer.

### Preparation

Before drying a sample, you must carry out the following preparations:

- Adjust against the existing measurement system
- Prepare the sample
- Set the drying program parameters

### Adjusting against an Existing Measurement System

A moisture analysis method often replaces another drying method (such as oven drying method) because it is simple to use and requires shorter analysis time. In this case, you should adapt this method to that of the moisture analyzer in order to obtain values comparable to those yielded by your standard reference method.

Perform parallel measurements:

- ▶ Take a fresh sample and divide it in half
- ▶ Determine the moisture content of the first half using your standard method of analysis
- ▶ Determine the moisture content of the second half using the following settings:
  - Fully automatic mode for the switch-off criterion
  - Lower temperature settings than for the oven drying method
  - Temperature setting for organic substances: 80–100°C
  - Temperature setting for inorganic substances: 140–160°C

If the result of the second analysis does not correspond to that of the first:

1. First, repeat the analysis using a different temperature setting
2. Then use the semi-automatic mode for the switch-off criterion (for example with a different loss rate per 24 s)

Change the switch-off criterion if required:

- Increase end-point recognition: Set the parameter to 2 mg/24 s or 1 mg/24 s
- Decrease end-point recognition: Set the parameter to 10 mg/24 s or 20 mg/24 s

### Preparing the Sample

Select a sample:

- ▶ Select a representative part of the whole substance as a sample.
  - Choose a representative number of individual samples for quality control
  - Choose enough samples to indicate a trend for in-process control
- ▶ If required, homogenize the product before a sample is taken by:
  - Mixing or stirring
  - Taking several samples from different areas of the product
  - Taking several samples at defined intervals
- ▶ Take only one sample at a time for a given analysis and prepare it as quickly as possible. In this way, it will not lose or gain moisture as a result of the ambient conditions.
- ▶ If several samples need to be taken simultaneously, the samples must be sealed in airtight containers to ensure that the storage conditions do not alter the state or condition of the samples:
  - Warm or highly volatile substances lose their moisture very quickly.
  - If you store the samples in a container, the moisture can condense on the walls of the container.
  - If the container is too big and not filled completely, the sample can exchange its moisture with the air remaining in the container.

- ▶ Mix the condensed moisture back in with a sample if necessary.

Prepare the sample:

- ▶ When crushing a sample, avoid any contact with heat.  
Heat results in moisture loss.
- ▶ Crush the sample using:
  - Pestle
  - Lab mill

If the sample is liquid containing solids, use one of the following tools:

- Glass stirrer
- Spoon
- Magnetic stirrer

- ▶ Use an appropriate tool for grinding the sample.

Use a disposable sample pan:

- ▶ Use only Sartorius disposable sample pans (inner diameter of 90 mm).  
Reusing sample pans leads to poor repeatability of results:
  - After cleaning, sample residues can still remain on the pan.
  - Residues from cleaning agents can evaporate during the next moisture analysis.
  - Scratches and grooves made during cleaning result in damage that forms points of attack for hot, rising air produced during the drying process (more pronounced buoyancy).



Apply the sample to the sample pan:

- ▶ Apply the sample to the sample pan in a thin, even layer (height: 2 to 5 mm, weight: 5 to 15 g); otherwise:
  - A sample applied unevenly will result in a nonuniform distribution of heat
  - A sample will not be dried completely
  - The analysis time will be unnecessarily extended
  - The sample will burn or a crust/skin will form on its surface as a result of a very thick layer
  - The crust makes it difficult or impossible for moisture to escape from the sample during the drying process
  - An uncertain and unknown quantity of moisture will remain in the sample

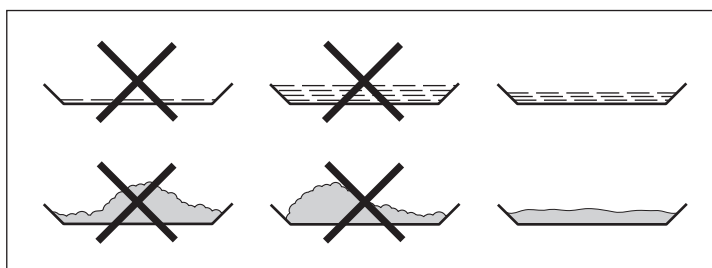

- ▶ Apply liquid samples, pasty samples, transparent samples, or samples that can melt to a glass-fiber filter (order no. 6906940); this provides the following benefits:
  - Uniform distribution due to the capillary effect
  - Liquids are prevented from beading together and forming drops
  - With larger surfaces, the moisture can evaporate faster
  - Colorless/transparent samples do not reflect
  - Considerably more convenient than the “sea-sand method”

When drying samples containing sugar, a crust or skin can form and seal the surface. A glass-fiber filter is particularly useful in such cases. The moisture can evaporate downwards through the surface of the filter. Crust/skin formation can be prevented or limited by placing the glass-fiber filter on top of the sample.

- ▶ Cover solid, heat-sensitive samples with a glass-fiber filter (order no. 6906940); this provides the following benefits:
  - Gentle heating, because the sample surface is shielded from excessive heat
  - Higher temperature setting can be selected
  - Uniformity of the sample surface
  - Fast evaporation of the moisture
  - Excellent repeatability for samples containing fat

### Heating Programs

Two heating programs are available for performing moisture analysis of a substance:

- Standard drying
- Gentle drying

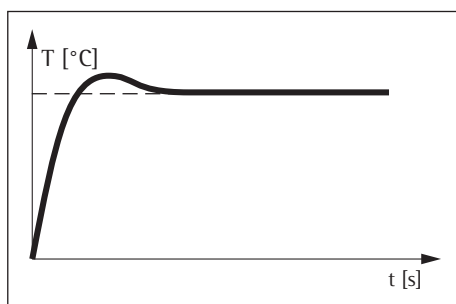

Standard drying:

For standard drying, you need to enter the final temperature. The final temperature is reached using an overshoot if necessary. The maximum set temperature is 160°C.

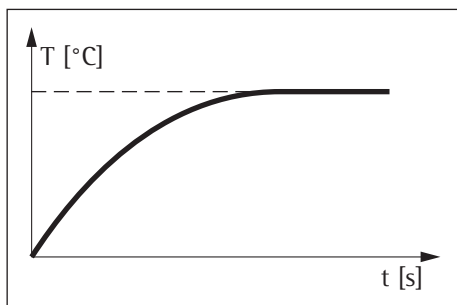

#### Gentle drying:

For gentle drying, you need to enter the final temperature. The maximum set temperature is 160°C. The target temperature is reached more slowly and the measurement time is extended. Gentle drying is recommended for sensitive samples.

#### Standby Temperature

Temperature set to defined value when the sample chamber is closed.

Heating only occurs when the analyzer is in a measurement cycle. The standby temperature is not the same as the measurement temperature.

The “Timeout Standby Temp.” can be set to 1 to 24 hours and is preset to 2 hours. To change the setting, see Chapter “System Settings (Setup Menu)”.

#### Initial Weight

The target weight (as a guide for applying a sample to the analyzer – not as a starting condition) can be entered by the user. The tolerance range can be freely selected, e.g.,  $\pm 0.5$  g.

#### Print Lines

When print lines are activated (1 or 2 lines with 20 characters each), additional information about the method, entered by the user, appears on the report and printout.

#### Filter

The user has the option of selecting between 0, 1, or 2 filters. During taring a message appears indicating that the configured number of filters must be placed with the sample pan for taring.

#### Target Value

The user can enter a target value with a tolerance range. During analysis a progress bar appears, indicating the progress of the measurement. At the end of the analysis, you can see whether the value is within the tolerance range.

**Starting the Analysis**

- After closing the hood:  
If the initial weight condition is met, the analyzer prompts you to close the hood. The start weight is accepted as soon as the sample chamber is closed and the measurement value is stable.

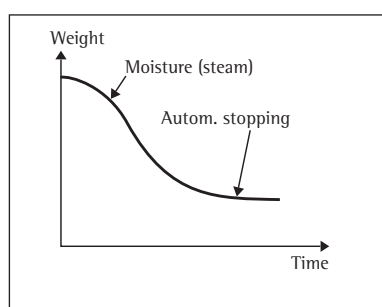
**End of Analysis**

- Fully automatic:  
The analysis ends as soon as the weight loss per 24 s is below an automatically detected threshold.
- Semi-automatic, absolute:  
The analysis ends as soon as the weight loss per the set interval is lower than a user-defined threshold (set in milligrams). The weight loss is entered by the user.
- Semi-automatic, percentage:  
The analysis ends as soon as the weight loss in percent is lower than a user-defined threshold (set in percent). The percentage is entered by the user.
- Time  
The analysis ends as soon as the specified time has elapsed.
- Manual:  
Switch off using the END key. The maximum analysis duration is 24 hours.

# Operating the Moisture Analyzer

## Switching the Analyzer On and Off (Standby)

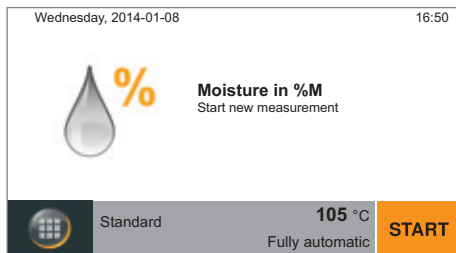

- ▷ The main screen appears after the moisture analyzer has been switched on.
  - The default language for the display text is English.
  - You can change the language (see “Setting the Language” on page 21).



- ▷ To switch the moisture analyzer to standby, select the menu key at the bottom left of the main screen on the display.

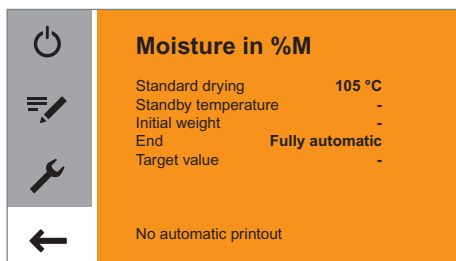

- ▷ The menu is displayed.



- ▷ Select the  button in the menu.
- ▷ The moisture analyzer switches to standby mode.



- ▷ To switch the moisture analyzer on again: Select  on the display. The moisture analyzer starts in the method most recently used before the analyzer was last switched off.

## Setting the Language

The default language for the display text is English.  
To change the language, proceed as follows:



- ▶ Select the menu key at the bottom left of the main screen on the display.

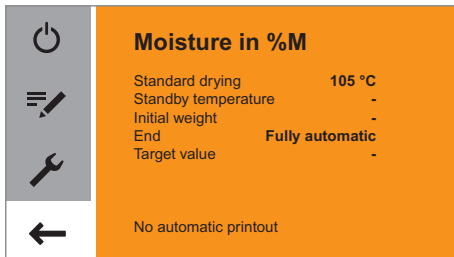

- ▶ The menu is displayed.



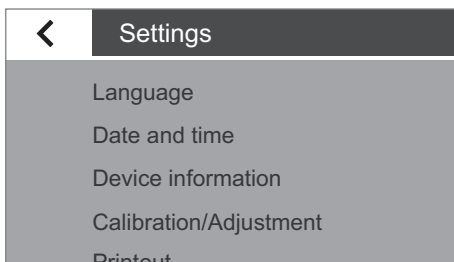

- ▶ Select the  (Setup) button in the menu.

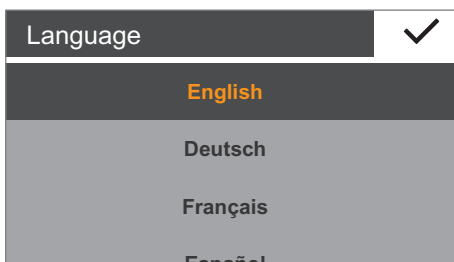

- ▶ The **Settings** window appears.
- ▶ Select **Language** or the top entry in the list.



- ▶ The **Language** settings window appears.
- ▶ Select the desired language, such as **Deutsch** (German).
- ▶ Select  to confirm.
- ▶ The display changes directly to the desired language.
- ▶ Select  to return to the menu.

## Operating Concept

This section explains the operating options available to you so that you can familiarize yourself with the moisture analyzer.

### Operating and Display Elements



**Sharp or pointed objects (such as ballpoint pens) can damage the device.**

– The touch screen should only be operated by lightly pressing it using the tips of your fingers. You can also operate the touch screen when wearing lab gloves.

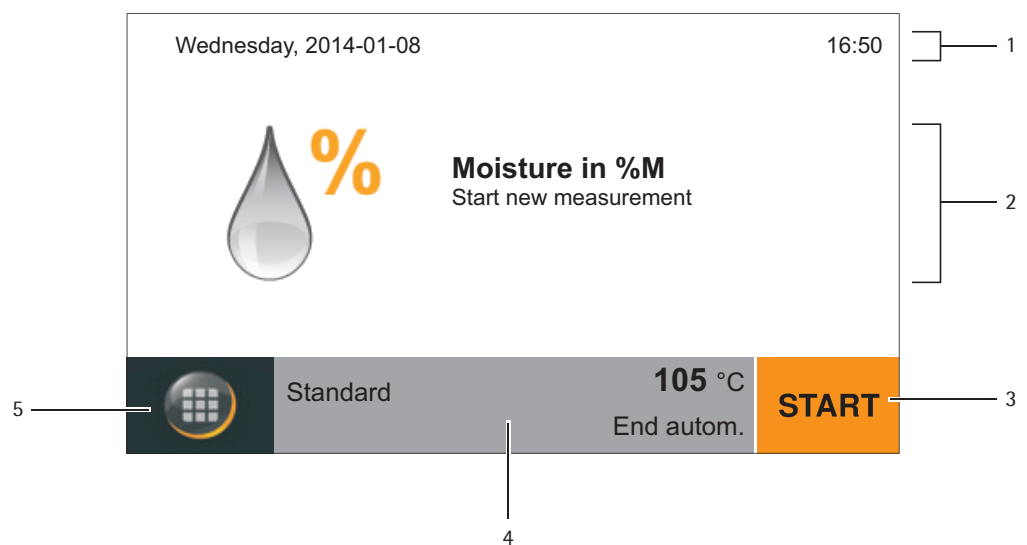

- 1 Current date and time
- 2 Selected result display for the method
- 3 Operate method, such as start moisture analysis
- 4 View settings for the selected method
- 5 Menu: Switch to the menu

## Menu

All settings for the moisture analyzer can be accessed via the menu.

- ▶ To access the menu, select the menu key at the bottom left of the display.
- ▷ The menu opens.

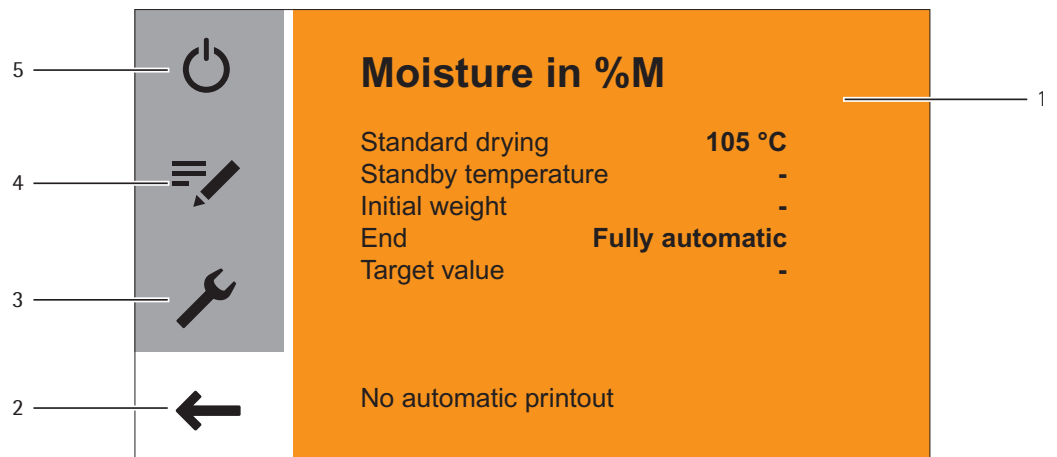

- 1 Method with current parameters
- 2 Back to the main screen
- 3 Setup menu: Open system settings (see page 26)
- 4 Change method parameters
- 5 Switch moisture analyzer to standby mode

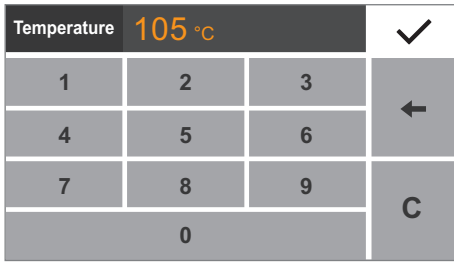

## Entering Numbers on the Number Pad

You can enter numeric values in the method parameters or system settings (such as the temperature setting for a heating program). A number pad appears on the display, which is always used in the same way.

- ▶ To enter numbers, select the desired numbers one after the other.
- ▷ The entered numbers appear at the top of the display.
- ▶ To correct the last entered number, select ←.
- ▷ The number is deleted. Then enter the correct number.
- ▶ To clear the entire entered value, select **C**.
- ▶ To confirm the entry, select ✓.

## Entering Text and Characters

A keyboard will appear when you have to enter text and characters.

- ▶ Select the individual characters one after the other. The entered text appears at the top of the display. If you hold down a character for longer, the special versions of that character (umlauts, accent marks) and special characters appear.

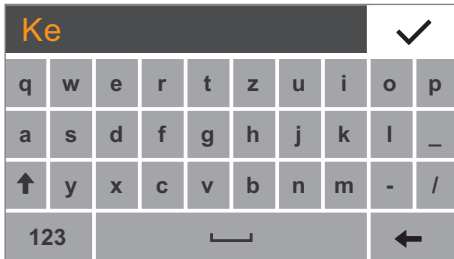

- ▶ Use the Shift key to switch the keyboard display between uppercase and lowercase letters.



- ▶ Use the 123 key to switch the keyboard display from letters to numbers (incl. special characters).



- ▶ Use the ABC key to switch the keyboard display from numbers to letters.



- ▶ Use the back arrow key to delete the last character.



- ▶ The ✓ key ends the process and saves character input.



## Scrolling in the Display

If more than one entry is available, you can scroll up and down through the display to select the desired entry.

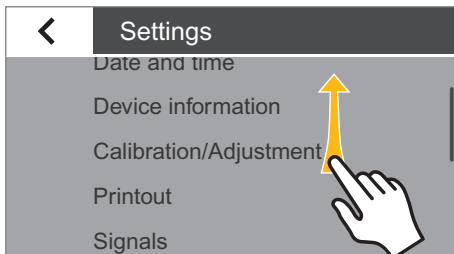

- ▶ To scroll, place your finger on the display and drag it slowly either up or down.
- ▶ The entries on the display move in the corresponding direction. While you are scrolling, a gray scroll bar appears on the right of the display, indicating where you are in the list of options.

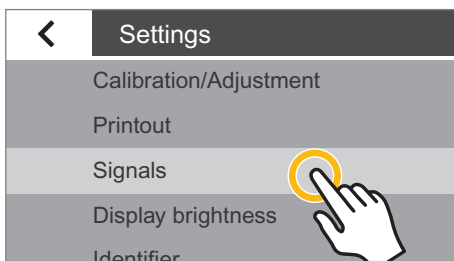

- ▶ Tap the desired entry to select it.

## System Settings (Setup Menu)

The **Settings** (Setup) menu contains all basic settings for the moisture analyzer.

### Opening the Menu and Changing the Settings



- ▶ Select the menu key on the main screen.

- ▷ The menu is displayed.

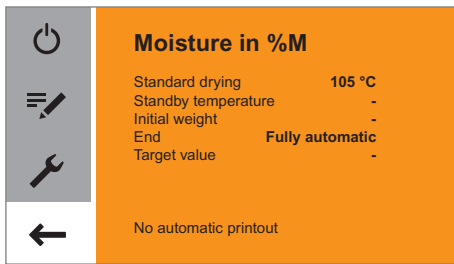

- ▶ Select the  (Setup) key in the menu.

- ▷ The **Settings** menu appears.

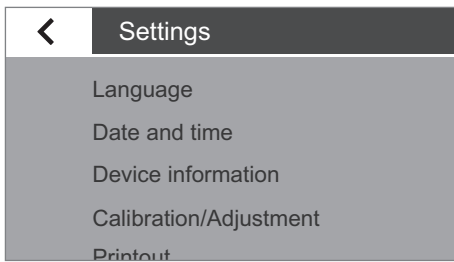

- ▶ To scroll, place your finger on the display and drag it slowly either up or down.
- ▷ The entries on the display move in the corresponding direction. While you are scrolling, a gray scroll bar appears on the right of the display, indicating where you are in the list of options.

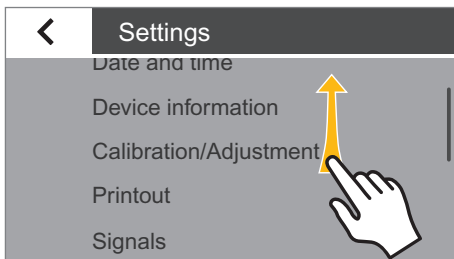

- ▶ Select a setting and make the desired change. Information about the available settings can be found from page 27.
- ▶ Select  to confirm your changes.
- ▶ Select  to return to the menu. The changed settings are active when you reach the first level of the menu again.

## List of Available Settings

This section contains information about all of the basic settings on the moisture analyzer, which can be defined in the **Settings** menu.

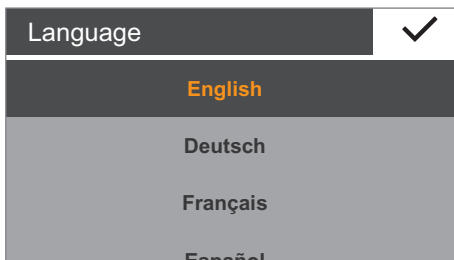

### Language

The language of the display text can be set here. English is set as the default language on the moisture analyzer (see “Setting the Language” on page 21).

The following languages are available:

- English
- German
- French
- Spanish
- Italian
- Japanese
- Russian
- Chinese
- Polish
- Portuguese
- Turkish

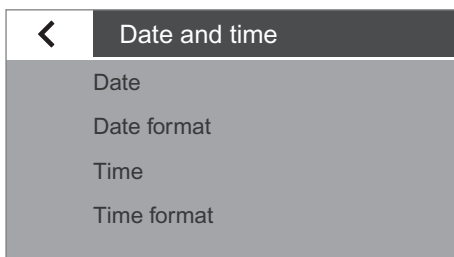

### Date and Time

The date, time, and display format can be set here.

Under **Date**:

- ▶ To set the date, select ···, enter the current date and confirm with ✓.

Under **Date format**:

- ▶ Select how the date is displayed and printed out.
  - **DD-MMM-YYYY**:  
The date is displayed in the order of day, month, then year.
  - **MMM-DD-YYYY**:  
The date is displayed in the order of month, day, then year.
  - **YYYY-MM-DD (ISO)**:  
The date is displayed in the order of year, month, then day.  
(The time is always displayed in 24-hour format with this setting.)

Under **Time**:

- ▶ To set the time, select ···, enter the current time and confirm with ✓.

Under **Time format**:

- ▶ Select how the time is displayed and printed out.
  - **24h**:  
The time is displayed in 24-hour format. (This is the only available setting when the date is set to ISO format.)
  - **12h (AM/PM)**:  
The time is displayed in 12-hour format. The hours before noon are displayed with **AM** and the hours after noon are displayed with **PM**.

## Device Information

The manufacturer, model, serial number and software versions of the moisture analyzer are displayed here.

Device information		✓
Manufacturer:	Sartorius	
Model:	MA37	
Serial number:	0034002458	
Version BAC:	00-53-01.01 CN:1701	
Version APC:	01-80-01.05 CN:0000	
Version DOC:	07-40-03.00 CN:0000	

## Calibration/Adjustment

The settings for calibration and adjustment of the moisture analyzer can be defined here.

Under **MA performance test**:

Test functions for different temperature ranges are available here. You can only use these functions with the ReproEasy pad (accessory).

Under **Weighing system adjustment**:

- ▶ Select the option of your choice.
  - **CAL-Extern**: Carry out calibration with an external calibration weight (see Chapter “Calibration and Adjustment”).
  - **Weighing only**: Use the weighing function to use the moisture analyzer as a simple lab balance (see Chapter “Calibration and Adjustment”, section “Weighing”).

Under **Calibration report**:

Here you can access the most recent calibration reports for the MA performance tests and weighing system adjustments. Up to 99 reports are saved per day. Calibration reports that are at least 30 days old are deleted.

## Printout

You can configure the settings for printing and data output here. Some of the settings depend on the configuration of the USB interface (see Chapter “USB Interface” on page 30).

Under **Printout measurement**:

- ▶ Select the settings for printing out the results on the connected lab printer.
  - **Printout measurement**: The printout can be activated and deactivated during the measurement here.
  - **Interim results**: If the printout is activated, you can also activate the output of intermediate values during the measurement here.
  - **Interval [sec]**: Enter the desired interval in seconds for the output of the intermediate results.

Under **Printout and report format**:

- ▶ Configure all settings for the output format.
  - **Result only**: Only the result of the moisture analysis is output.
  - **With GLP and method parameters**: The GLP data and parameters used for the moisture analysis are also output.

<	Calibration/Adjustment
	MA performance test
	Weighing system adjustment
	Calibration report

<	Calibration report
	MA performance test
	Weighing system adjustment

<	Printout
	Printout measurement
	Printout and report format

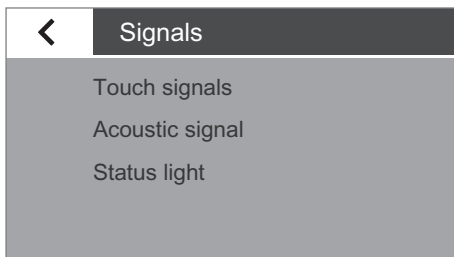

## Signals

The key tones, acoustic signals, and process status light can be switched on and off here.

The following settings are available for each signal:

- **On:** The signal is activated.
- **Off:** The signal is deactivated.

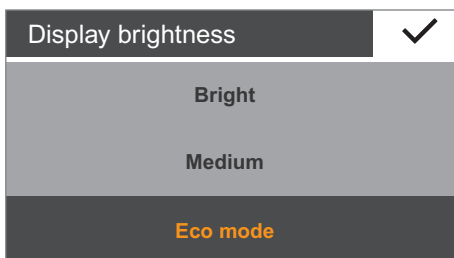

## Display Brightness

The brightness of the display can be set here.

The following brightness levels are available:

- **Bright**
- **Medium**
- **Eco mode:** Energy-saving mode (factory setting): The brightness is reduced after 2 min. of inactivity. To reactivate the normal brightness: Touch the screen or open the heating module. During measurement and during the results display, eco mode is deactivated.

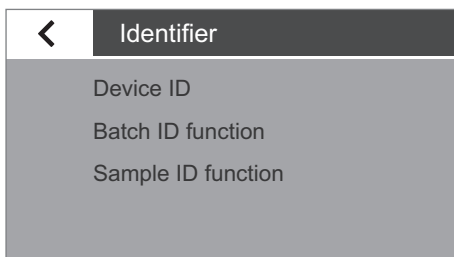

## Identifiers

The identifiers for the printout can be defined here.

- The **Device ID** identifier is entered here once. The device ID can be a maximum of 14 characters long.
- The **Batch ID** and **Sample ID** functions can be activated here. The user must then enter the batch and sample IDs before each measurement routine. Batch and sample IDs cannot exceed 20 characters.

Under **Device ID:**

The device identifier (ID) is printed on the GLP report in the header.

- ▶ To set the device ID, select **Device ID**, enter the desired device ID and confirm with ✓.

Under **Batch ID function:**

The batch ID (L ID) is queried once at the beginning of the measurement routine.

- ▶ If you wish to print the batch ID, activate this option.

Under **Sample ID function:**

The sampleID (S ID) is queried once at the beginning of the measurement routine.

- ▶ If you wish to print the sample ID, activate this option.



To enter and delete numbers and text, e.g., for the sample ID, see “Entering Text and Characters” on page 24.

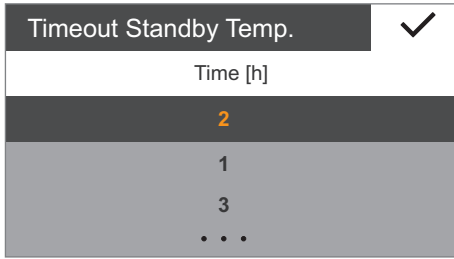

sorted by date, **Timeout standby temp.**

The timeout for the standby temperature can be set here.

- ▶ To set the time, select ..., enter the desired time and confirm with ✓ (entry in hours from 1 h to 24 h).

### USB port

The settings for the data transfer to a peripheral device (such as a PC or printer) can be defined here.

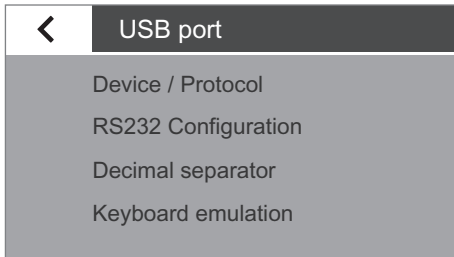

Depending on the cable and peripheral device connected to the moisture analyzer, various options are available in the menu. The moisture analyzer automatically detects the type of connection.

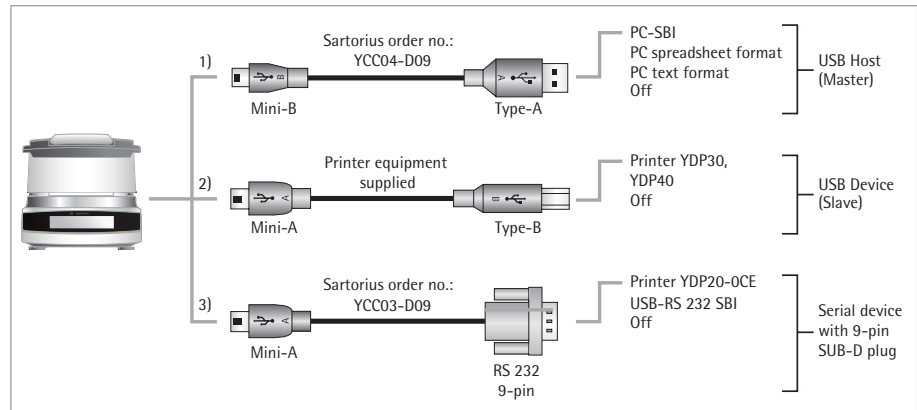

There are several ways to connect the device via USB:

#### 1) Connection to a PC via USB Cable (Mini-B to USB A)

Under **Device/Protocol**:

- ▶ Select the data format for the transfer to the PC.
  - **PC - SBI**: Driver for PC required (CDC Virtual Com Port). The data is sent via SBI protocol using a virtual serial interface. Additional information can be found in Chapter “USB Interface”, section “Direct Transfer of Data (PC)”.
  - **PC spreadsheet format**: The analyzer transmits the data via keyboard command (keyboard emulation) to the currently opened application on the PC in spreadsheet format.
  - **PC text format**: The analyzer transmits the data via keyboard command (keyboard emulation) to the currently opened application on the PC in text format.
  - **Off**: Data transmission is deactivated.

Under **Decimal separator** (also available when “PC spreadsheet format” has been

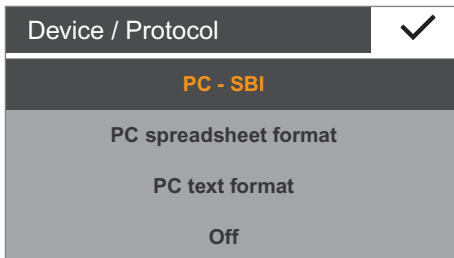

selected):

- **Decimal point** (default setting): The number value is transmitted with a decimal point to the PC program (example: 99.963 g).
- **Decimal comma**: The value is transmitted with a decimal comma to the PC program (example: 99,963 g).

Under **Keyboard emulation** (also available when “PC spreadsheet format” or “PC text format” has been selected):

- **Universal (Num Lock on)** (default setting): Data is sent as special keyboard characters in ASCII format (ALT + number pad).  
Requirement: Numbers lock must be turned on on the PC keyboard.
- **English (USA)**: Data is sent according to a keyboard set to English (USA).  
Requirement: For PC applications, such as MS Excel, the keyboard must be set to English (USA).



You can find more information in Chapter “USB Interface”.

## 2) Connection to Sartorius Lab Printer via the Supplied Printer Cable

Under **Device/Protocol**:

- ▶ Select the desired setting for the connection to the printer.
  - **YDP30/YDP40**: The connected printer is detected automatically and the connection is established.
  - **Off**: The connection to the printer is deactivated.

## 3) Connection to a Serial Printer or Another External Serial Device via a 9-pin Serial Interface (USB Mini-A to RS-232)

Under **Device/Protocol**:

- ▶ Select the desired setting for the connection to the device.
  - **Printer YDP20-OCE**
  - **USB-RS232 SBI**
  - **Off**: The connection is deactivated.

Check the settings for **Printer YDP20-OCE**:

- ▶ Set the printer to the default setting: 1200 baud, 7 bits, odd parity, 1 stop bit, CTS/RTS handshake

Under **RS-232 Configuration**:

This option can be selected if under **Device/Protocol** the setting **USB-RS232 SBI** has been selected.

- ▶ Select the desired setting for the RS-232 interface.
  - **Baudrate**: 600 to 19,200 (default setting: 9600)
  - **Databits**: 7 bits or 8 bits (default setting: 8 bits)
  - **Parity**: Odd, even, or none (default setting: odd)
  - **Stopbits**: 1 bit or 2 bits (default setting: 1 bit)
  - **Handshake**: Software (XON, XOFF), hardware (CTS, RTS), or off [default setting: hardware (CTS, RTS)]

### Service mode/Service access

This function is used by the Sartorius Service Center and can only be accessed by authorized service technicians.

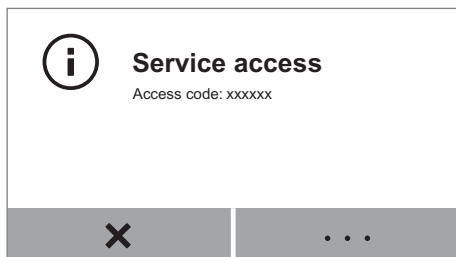

### Reset

All settings can be reset to the factory settings here.

- ▶ When the security prompt appears, select **Yes, reset** and confirm with ✓. The moisture analyzer is reset and restarts.



# Moisture Analysis

- Purpose:** The moisture analyzer can be used to determine the moisture content of liquid, pasty, or solid samples.
- Accessories:** Depending on the consistency of the sample, one or two filters are recommended in order to distribute the sample optimally in the sample pan.
- Liquid sample: Tare one filter with the sample pan, then distribute the sample drop by drop onto the filter.
  - Pasty sample: Tare two filters with the sample pan, then place the sample between the two filters and press together evenly.
  - Solid sample: Distribute the granulated sample evenly onto the sample pan without a filter. Use one or two filters for solid samples that liquefy at high temperatures or contain fat or sugar, in order to prevent crusting.



## Danger of poisoning or caustic burns!

Substances that contain poisonous or caustic ingredients may produce poisonous gases when dried, which can cause irritation (to the eyes, skin, or airways) or nausea and lead to serious injury or death.

- These samples must only be dried in a laboratory hood.



## Corrosion due to aggressive vapors!

Substances that emit aggressive vapors when heated may cause condensation to form on cooler housing parts and lead to corrosion.

- Use small sample quantities of these substances.

## Viewing and Changing Method Parameters

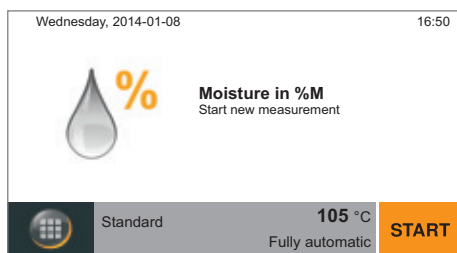

Before starting the moisture analysis, you can view the current parameters and change them if necessary.

- A method configuration for moisture analysis is preset. You can change and save the parameters to suit your requirements.

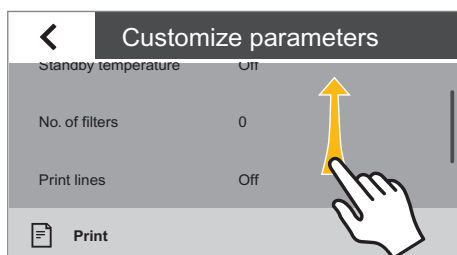

The most important parameters (method name, temperature, switch-off criterion) are displayed.

- ▶ To check or view additional parameters, select the gray button at the bottom of the main screen on the display.
- ▷ A summary of the current parameters is displayed.

If a lab printer is connected, you can print out the method parameters:

- ▶ Select the print symbol.
- ▷ The parameters are printed out.
- ▶ Select ◀ to close the display.



- ▶ To change the parameters, select the menu key at the bottom left of the main screen on the display.

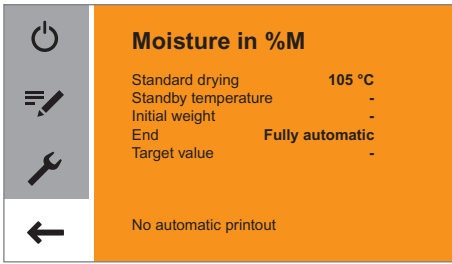

▶ The menu is displayed.



▶ Select the  button in the menu.

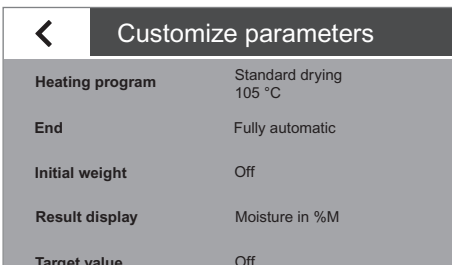

▶ The current method parameters are displayed.

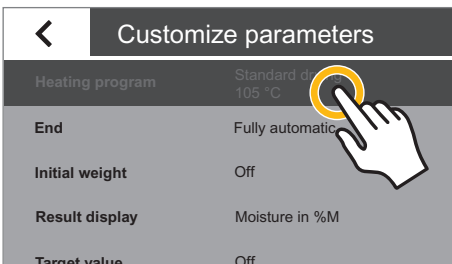

▶ Select the parameter you wish to change, such as “Heating program.”

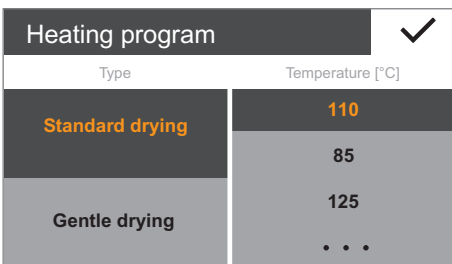

▶ Set the parameters to suit your requirements. Select ... if necessary and enter the desired values (see “Entering Numbers on the Number Pad” in Chapter “Operating the Moisture Analyzer”).

▶ Select ✓ to confirm.

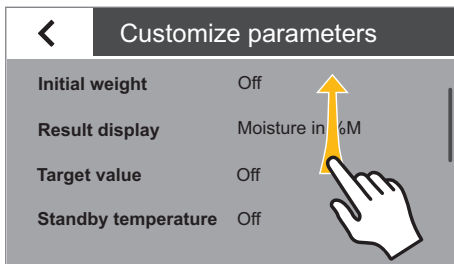

- ▶ Scroll through the list if necessary and change further parameters.
- ▶ When you are finished making changes, select ◀.

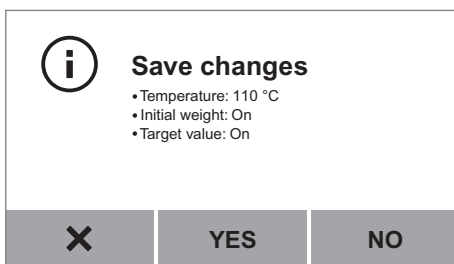

- ▷ The changed method parameters are displayed.
- ▶ Select the desired option:
  - Make further changes: Select **X**. This takes you back to the list of parameters.
  - Reject changes: Select **NO**.
  - Save changes: Select **YES**.

- ▷ The menu is displayed.
- ▶ To return to the main screen, select ◀.

## Performing the Moisture Analysis

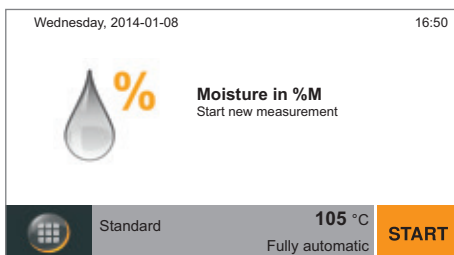

When all parameters have been set to suit your requirements, you can start the moisture analysis.

- Observe the following instructions in order to ensure successful measurement:
- Wear gloves for each measurement, so that the liquid in the sample is not influenced by handling.
  - Remove the sample directly from the process or keep it in an airtight and watertight container until measurement.
  - Ensure that the sample is representative for the product and is homogeneous (shake, stir, or mix before measurement).
  - If using a filter or filters, store the filters in airtight and watertight packaging.

**START**

- ▶ Select **START** on the main screen or open the hood.

If you selected **START** on the main screen:

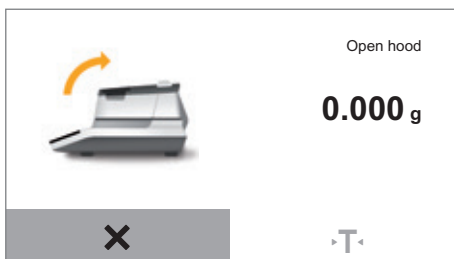

- ▶ Open the hood now.

- ▷ The next step is displayed when the hood is opened.



- ▶ Place an empty sample pan on the analyzer, along with one or two filters if necessary. The number of filters depends on how many filters are set in the parameters for the current method.
- ▶ Close the hood.
- ▷ The moisture analyzer tares automatically.

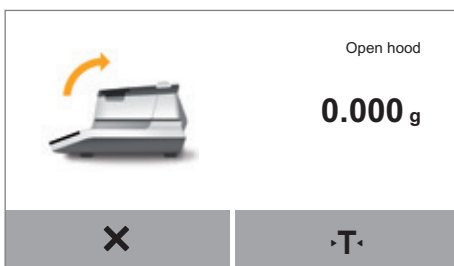

- ▶ Open the hood.

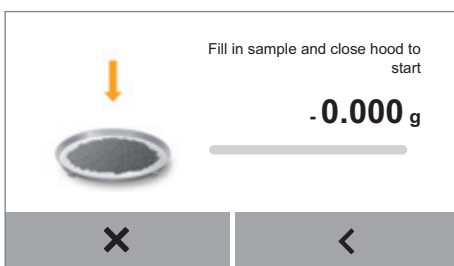

- ▶ Place the sample on the sample pan or filter(s).

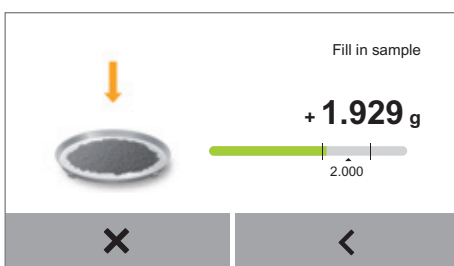

- ▷ If you have activated the “Initial weight” option in the method parameters, a target value display appears.
- ▶ Add the sample to the sample pan slowly. When the sample quantity reaches the preset range, the target value display turns green.

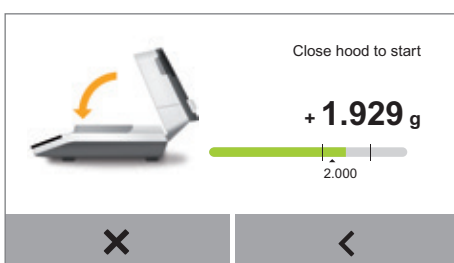

- ▶ Close the hood.
- ▷ The moisture analysis starts automatically. During the measurement, the process status light on the analyzer flashes, if the light has not been switched off in the menu.

- ▷ The current measurement value and progress are shown on the display during the moisture analysis.

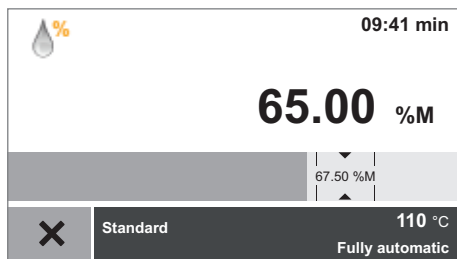

- If a target value is set, the measurement process is displayed as a bar diagram. The target value is marked and tolerance limits are displayed.

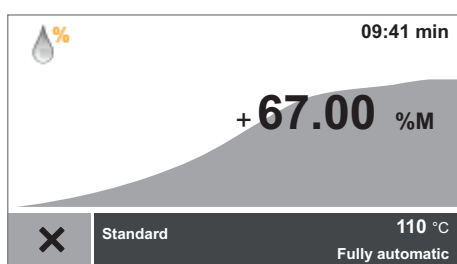

- If no target value is set, the measurement process is displayed as a curve diagram.

The following information is also shown on the display:

- Information bar at the top right: measurement time expired
- Function bar below: method name, target temperature, switch-off criterion

- ▶ To cancel the moisture analysis before it is finished: Select **X**.

- ▷ When the moisture analysis is finished, the moisture content of the sample is shown on the display. The process status light on the analyzer flashes three times and then goes out.

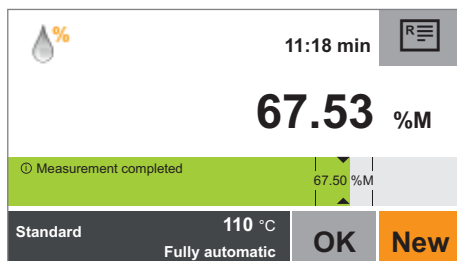

- If a target value is set, the moisture content is displayed as a bar diagram.
  - Bar is green: Result is within the tolerance limits.
  - Bar is red: Result is not within the tolerance limits.
  - Bar is orange: Measurement was canceled.

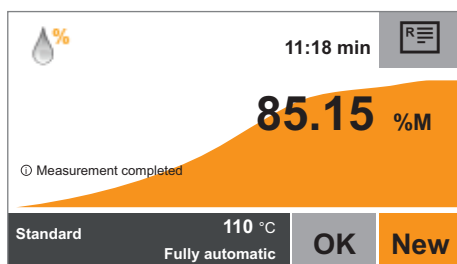

- If no target value is set, the moisture content is displayed as a curve diagram.

- ▶ Select the desired option:
  - To perform another moisture analysis using this method: Select **NEW**.
  - To view the report and print it out if desired: Select **R**.
  - To exit the measurement: Select **OK**.

## Printing Out the Analysis Report

If a lab printer is connected, you can print out the result of the moisture analysis.



- ▶ Select .
- ▷ The analysis report is printed out.



The settings for the analysis report can be configured in the system settings (see section “Printout” in Chapter “System Settings”). Further information and an example of an analysis report can be found in Chapter “ISO/GLP-compliant Printout”.

## Removing a Sample



### Danger of burns due to hot sample pan!

The sample and sample pan may be very hot.

- Do not touch the sample pan.
- Use sample tongs (accessory) to remove the sample.

- ▷ When you have exited the measurement by selecting **OK**, you can remove the sample from the moisture analyzer.

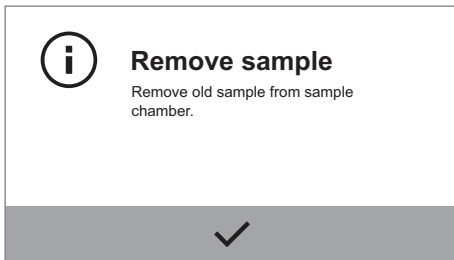

- ▶ Open the hood.
- ▶ Remove the sample pan from the moisture analyzer using sample tongs.
- ▶ Close the hood.
- ▶ Allow the sample to cool down and dispose of it properly.

and therefore marked with a  symbol.

## MA Performance Test

The performance test can be used to check whether the analyzer has a fault or is ready for operation. During a performance test, both the heating unit and the weighing system are tested at the same time. You will need a ReproEasy pad (accessory) in order to carry out a performance test.

### Starting the Performance Test

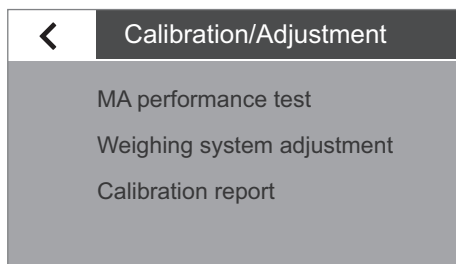

- ▶ Select "MA performance test."
- ▷ The display switches to a view with three heating temperatures.



Please ensure that the device has not been heated for at least one hour before a performance test is carried out.

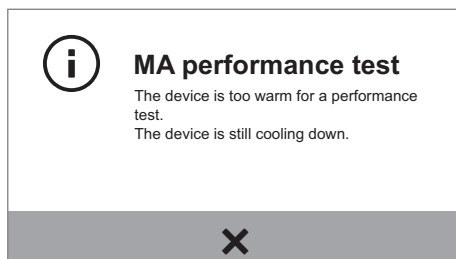

- ▶ Select "X" to confirm the message and start the performance test again later.

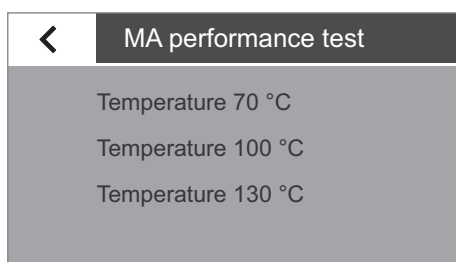

- ▶ Select one of the suggested temperatures given for the method you are using.

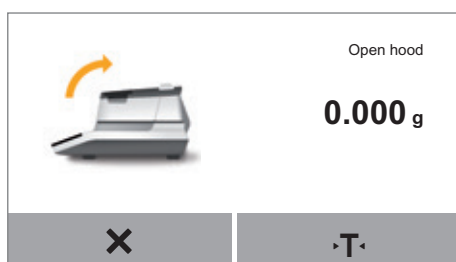

- ▶ Open the hood.
- ▷ The next step is displayed when the hood is opened.

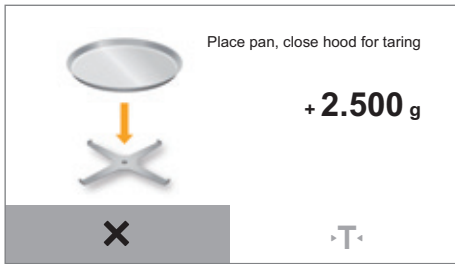

- ▶ Place a sample pan on the analyzer.
- ▶ Close the hood.
- ▷ The moisture analyzer tares automatically.

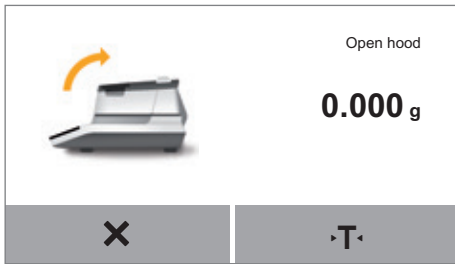

- ▶ Open the hood.

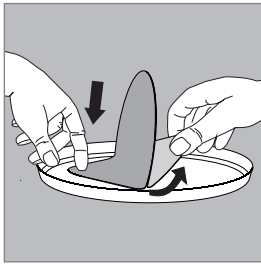

- ▶ Open the packaging of the ReproEasy pad (accessory) and remove the pad.
- ▶ Remove the protective wrapping.

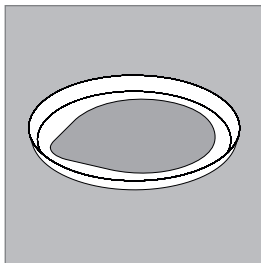

- ▶ Affix the pad to the center of the sample pan, sticky side down.

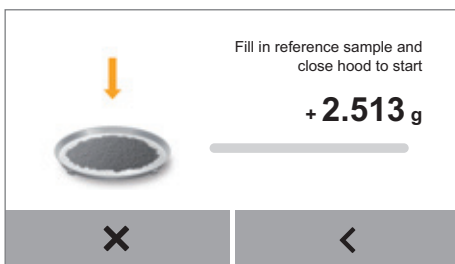

- ▶ Place the ReproEasy pad reference sample (accessory) on the sample pan.

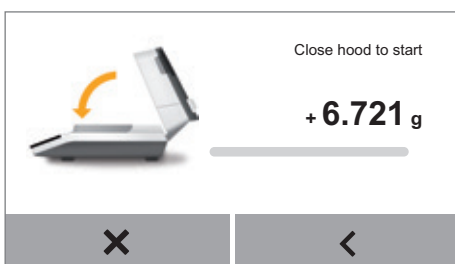

- ▶ Close the hood.
- ▷ The performance test starts automatically.
- During the performance test, the process status light on the analyzer flashes, if the light has not been switched off in the menu.



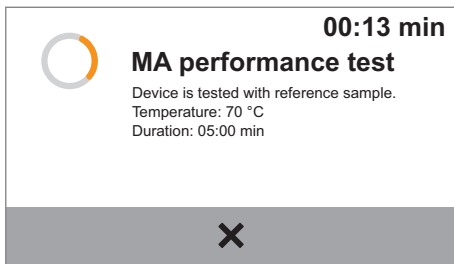

- ▷ The display shows the progress of the test and the remaining time.

## Performance Test Measurement Not Successfully Completed

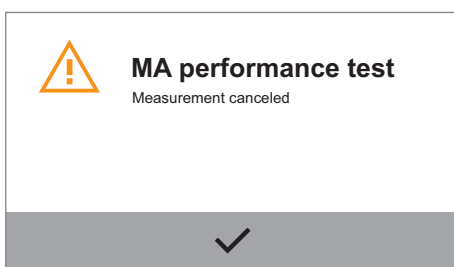

- ▷ The message “**Measurement canceled**” appears.
- ▶ Select ✓ to confirm.
- ▷ The display switches back to the menu.

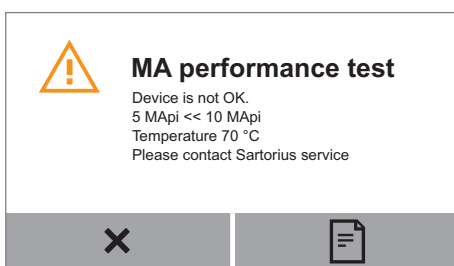

If a fault has been detected:

- ▷ The message “**Device is not OK**” appears.
- ▶ Select ✕ to confirm.



Contact Sartorius service if the message “**Device is not OK**” appears.

## Performance Test Successfully Completed

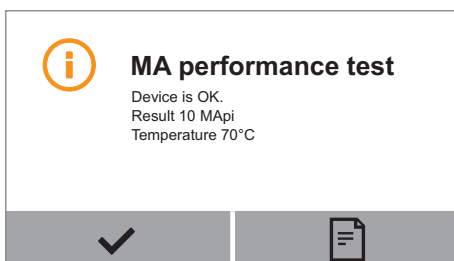

- ▷ If the test is successful, the message “**Device is OK**” first appears. Then the analyzer indicates that the sample can be removed.

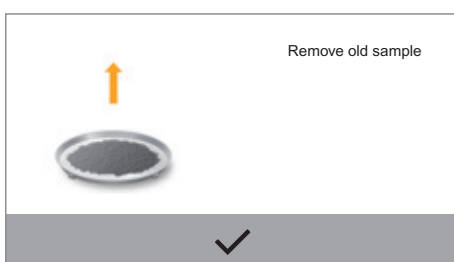

- ▶ Select ✓ to confirm.
- ▷ You can remove the sample and return to the menu.

# Calibration and Adjustment

**Background** During **calibration**, a calibration weight is used to determine how much the displayed value deviates from the actual measurement value. This deviation is compared against a preset target value. The subsequent **adjustment** corrects this deviation or reduces the permissible error limits. Calibration and adjustment are combined in one process in the moisture analyzer. After each calibration the analyzer is automatically adjusted.

**When and How Often** The moisture analyzer must be calibrated and adjusted, for example:

- When the ambient conditions have changed (temperature, humidity, or air pressure)
- When the moisture analyzer is set up in a different location or moved in its current location.



An external calibration weight is required for calibration and adjustment (100 g). Please note the tolerance of the calibration weight being used.

## Calibrating the Moisture Analyzer

▶ Make sure that the pan support is empty.



▶ Select the menu key on the main screen.

▷ The menu is displayed.

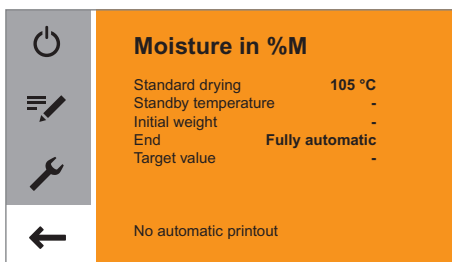

▶ Select the  (Setup) key in the menu.

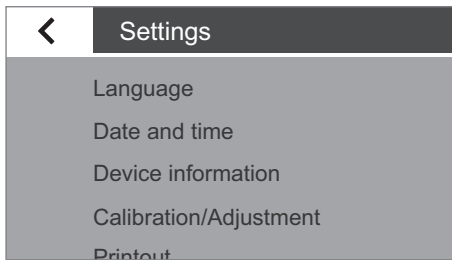

- ▷ The **Settings** menu appears.
- ▶ Select **Calibration/Adjustment**.

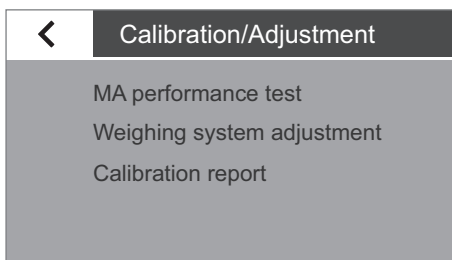

- ▶ Select **Weighing system adjustment**.
- ▶ Select **CAL-Extern** to calibrate the analyzer using an external calibration weight.

- ▷ The **Calibration/Adjustment** window appears.
- ▶ Close the hood and select ✓ to confirm.
- ▶ The **CAL-Extern** window appears.
- ▶ If necessary, please zero the integrated balance.

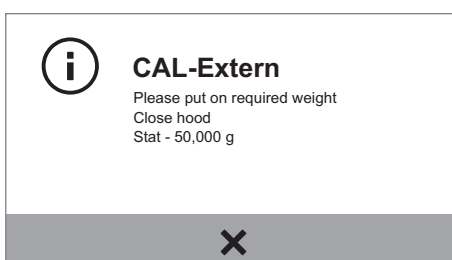
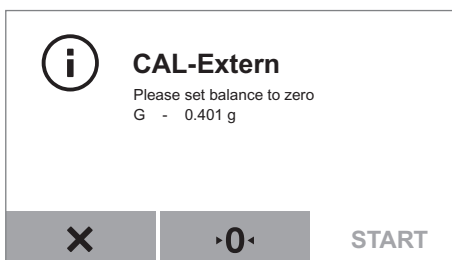

- ▷ A message appears on the display, prompting you to place the calibration weight (50 g) on the analyzer.
- ▶ Place the calibration weight on the pan support.
- ▷ Calibration starts automatically.  
When calibration is complete, a report appears on the display. The report gives the deviation detected during calibration. You are asked whether the weighing system should be adjusted. After adjustment the report shows the result of the adjustment.
- ▶ Close the report: Select **X**.
- ▷ The moisture analyzer is now calibrated. If you have also carried out an adjustment after calibration, the moisture analyzer is also now adjusted.

## Viewing the Calibration Report

- ▶ To view the most recent calibration reports: Go to the **Calibration/Adjustment** menu and select the **Calibration report** submenu.

Here you can select the most recent reports for the MA performance tests or weighing system adjustments and then access the most recent calibration reports, which are sorted by date.

Up to 99 entries per day are saved. Calibration reports older than 30 days are deleted.

- ▷ Menu Calibration report.

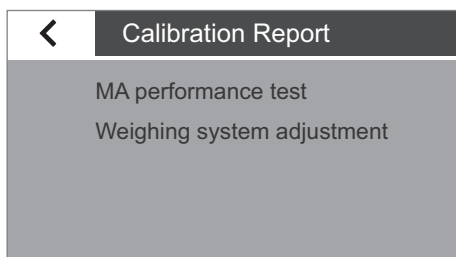
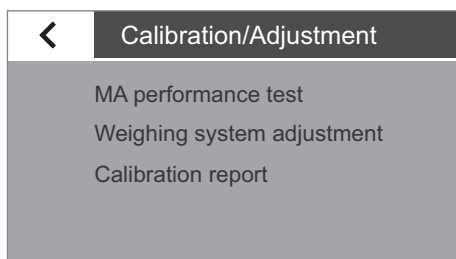

### Example of a Calibration Report:

```

-----
2014-07-29      12:02
      Sartorius
Mod.           MA37-1
SerNo.        0031710609
BAC:          00-53-01
APC:          01-80-01
DOC:          07-40-03
-----
2014-07-29      12:02
External calibration
Start: manually
Set   +   50.000 g
Dev   -   0.002 g
External adjustment
Dev   +   0.000 g
Temp  +   23.7 °C
-----
Name:
-----

```

## Weighing

The moisture analyzer also has a simple weighing function which can be opened via the system menu.



- ▶ Select the  (Setup) key in the menu.

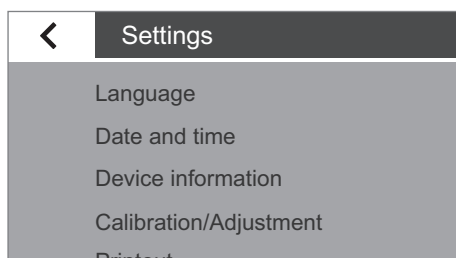

- ▶ The **Settings** menu appears.

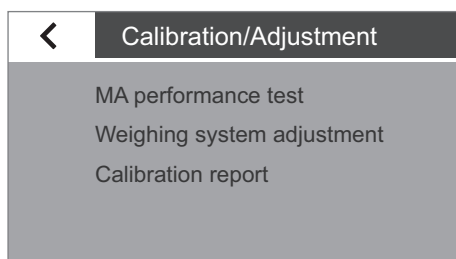

- ▶ Go to **Calibration/Adjustment** and select **Weighing system adjustment**.
- ▶ Select **Weighing only**.

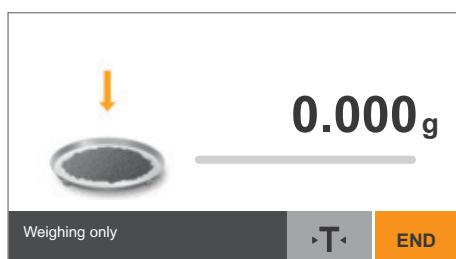

- ▶ The weighing screen appears.  
You can now use the moisture analyzer as a simple lab balance.



- ▶ To exit the weighing function, select **END**.
- ▶ Select **<** multiple times to return to the menu.

# ISO/GLP-compliant Printout

## Features

You can have the device information, device ID, and the current date printed before (GLP header) and after (GLP footer) the values from the weighing series. The following data is printed:

GLP header:

- Date, time at the start of a weighing series
- Manufacturer
- Model
- Model serial number
- Software version number of the device (BAC)
- Software version number of the display (APC)
- Software version number of the heating module (DOC)
- Device ID with max. 14 characters (if activated under system settings)

GLP footer:

- Field for signature

## Configuration

To print out the ISO/GLP report, define the following system settings (see Chapter “System Settings”, section “Printout”):

- ▶ Activate ISO/GLP-compliant printouts:  
In the **Printout** menu under **Printout and Report Format**, activate the **With GLP and method parameters** option.

## Operation

- ▶ Print out the report after moisture analysis: Select .

**Example of Analysis Report**

```
-----  
2014-05-12      09:46  
      Sartorius  
Mod.           MA37-1  
SerNo.        0000037919  
BAC:          00-53-01  
APC:          01-80-01  
DOC:          07-40-03  
-----
```

```
Type  
      Standard drying  
Temperature  
      40 °C  
Standby  
      Off  
Initial weight  
      Off  
End  
      Fully automatic  
Result display  
      Moisture in %M  
Target value  
      Off  
No. of filters  
      0  
Start time  
      10:03  
Start weight  
      + 4.564 g  
Measurement time  
      01:15 min  
Result  
      8.16 %M  
Final weight  
      + 4.531 g  
End of analysis  
-----
```

```
Name:  
-----
```

# USB Interface

## Communication with Peripheral Devices

**Purpose:** The interface is used to exchange data with connected peripheral devices: Measured values and parameters are sent to a printer or PC. Control commands and data inputs can also be sent to the analyzer from connected devices such as a PC. The USB interface can be used to transmit data via the SBI protocol.

The following connections to peripheral devices are possible:

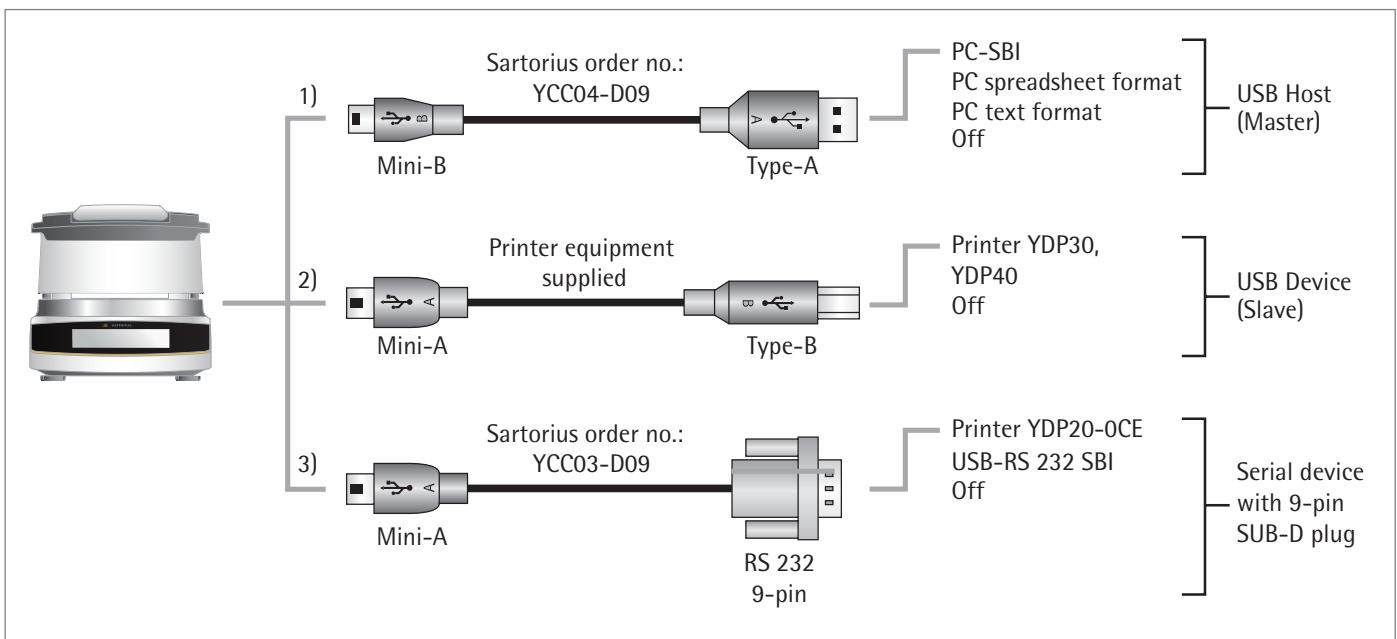

## Direct Transfer of Data (PC)

### Requirements:

- PC with Windows 7, Windows 8, Vista, Windows XP, or 2000 operating system
- A to Mini-B USB connection cable from PC to moisture analyzer, Sartorius order no.: YCC04-D09
- PC with internet connection



The USB driver for the virtual interface is listed with Microsoft® and is available online via the Microsoft® update service.  
PC without internet connection: To load the USB driver, please contact your local Sartorius Service Center.

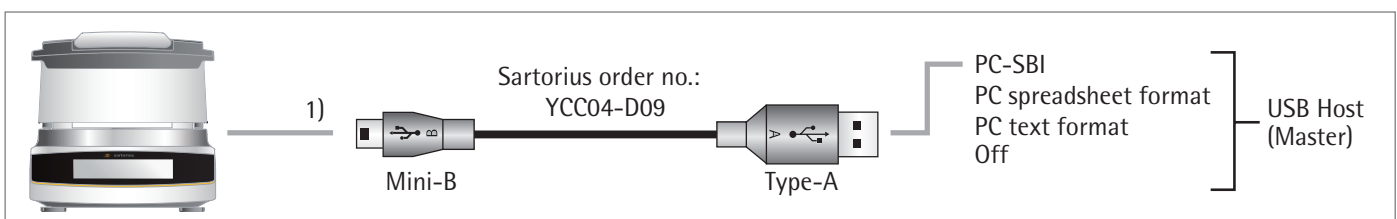



**(1) USB Connection as PC Keyboard without Additional Driver via a PC with Table or Spreadsheet Editor (e.g., Microsoft® Office or OpenOffice)**

- ▶ Connect the moisture analyzer to your PC using the intended USB connection cable.



- ▶ To open the system settings of the moisture analyzer, select (Setup) in the menu.



Device / Protocol	✓
PC - SBI	
<b>PC spreadsheet format</b>	
PC text format	
Off	

- ▶ To open the **PC spreadsheet format** menu item on the moisture analyzer, go to **USB port** and select **Device/Protocol**.

**Setting Options:**

- ▶ To change the moisture analyzer to suit your PC settings, define the following system settings (you can find more information on this in Chapter “System Settings”, USB Interface):
  - Choose the character to be used as a decimal point for the spreadsheet calculation.
  - Set the PC keyboard to English (USA) instead of Universal (numbers lock on).
- ▶ Once data has been transferred to your PC, the following appears on the PC:
  - When **PC spreadsheet format** is set on the moisture analyzer, e.g. with Microsoft Excel open
    - ▶ Activate the cursor in the PC application.
    - ▶ Then select or on the moisture analyzer for the respective data output.

	A	B	C	D
22	Result display	Moisture in %M		
23	Target value	On		
24	Target value	2.00 %M	Target value	2 %M
25	Tolerance target +/-	0.20 %M	Tolerance target +/-	0.2 %M
26	Number of filters	1		
27	Start time	13:36		
28	Start weight	+ 4.606 g	Start weight	4.606 g
29	Measurement time	02:00 min		
30	Result	0.24 %M	Result	0.24 %M
31	Final weight	+ 4.595 g	Final weight	4.595 g
32	Measurement compl.			
33	-----			
34	Name:			
35				
36	-----			

- When **PC text format** is set on the moisture analyzer, e.g. with Microsoft® Excel open
- ▶ Activate the cursor in the PC application.
- ▶ Then select  or  on the moisture analyzer for the respective data output.

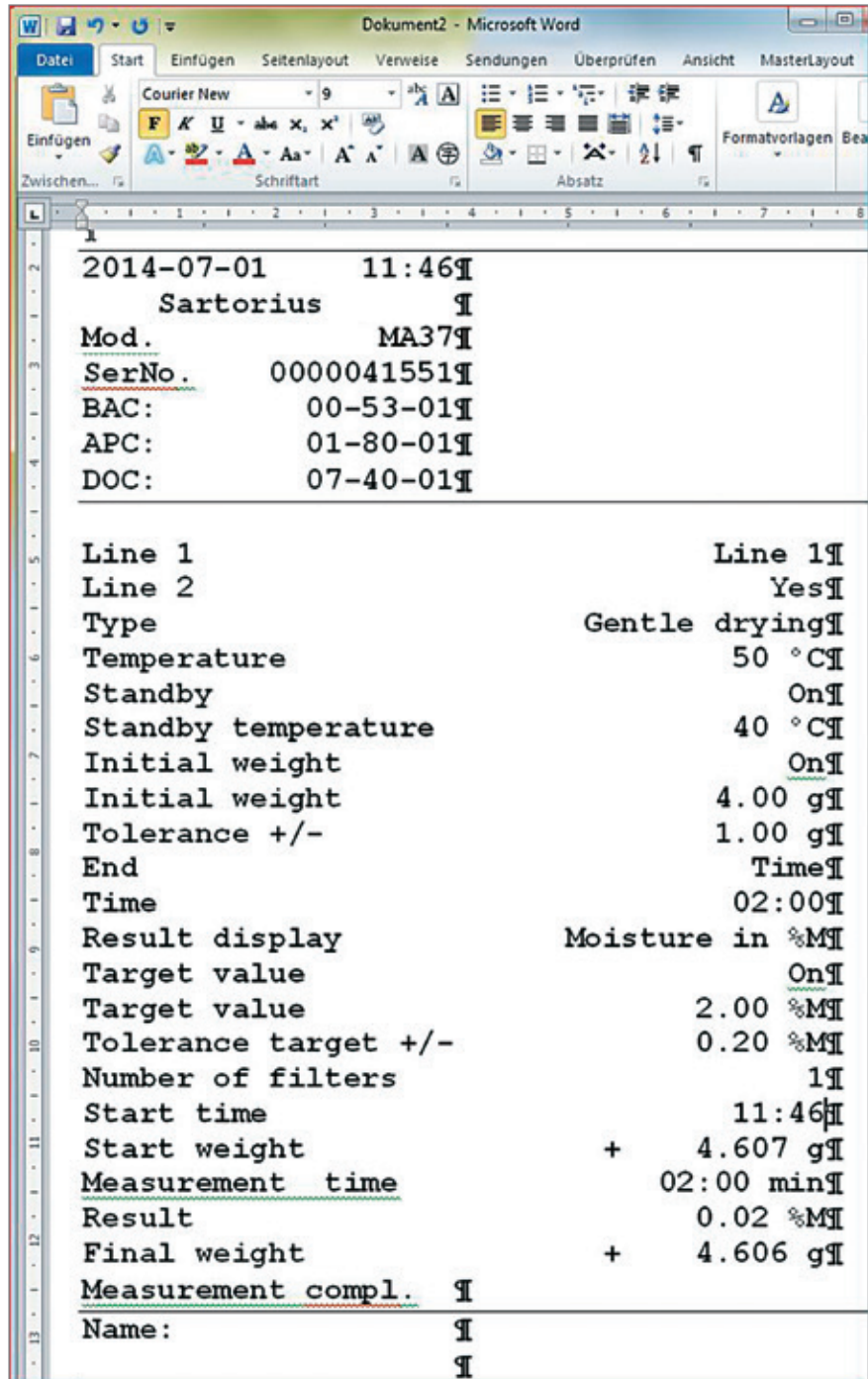

### Connection with Sartorius Lab Printer YDP30, YDP40

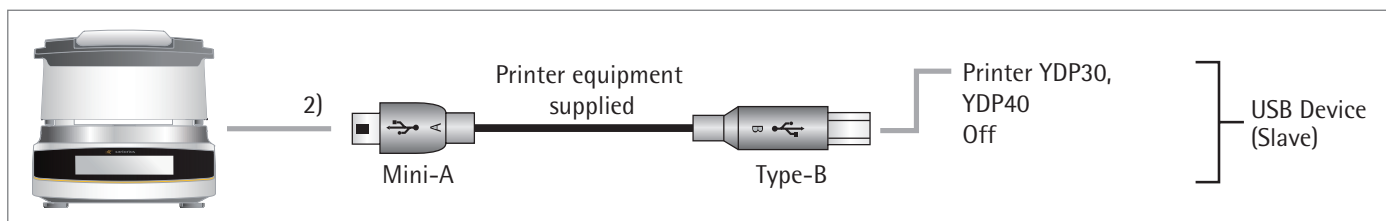

- ▶ Connect the moisture analyzer to the Sartorius printer using the supplied USB connection cable.
- ▷ The moisture analyzer detects the printer automatically. No settings need to be changed.

### Connection for 9-pin RS-232 Configuration

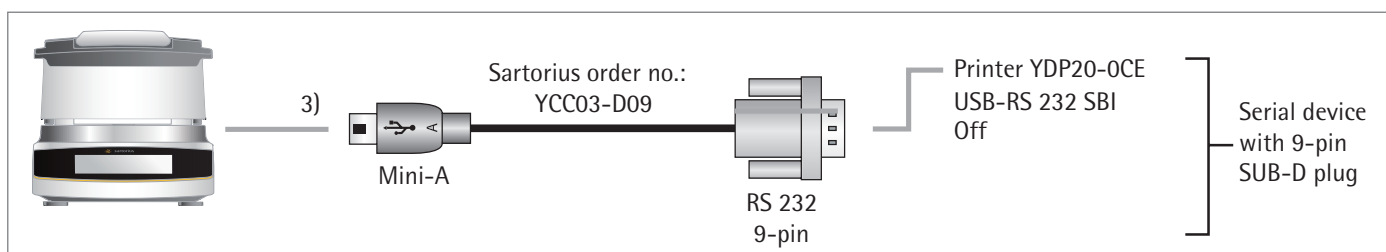

- ▶ Connect the peripheral device to the moisture analyzer using the Sartorius YCC03-D09 connection cable (RS-232, 9-pin, PC-compliant assignment).
- ▶ Define the desired settings: See Chapter “System Settings,” section “USB Interface.”

## Interface Specification

### Data Output

The print command can be triggered by selecting .

### Data Output Formats

Values are always output with an ID; if more than 22 parameters are set, the values are printed on two lines. Intermediate values are also output in other formats; intermediate values are always printed on one line.

You can activate the printout in the **Printout** menu (see section “Printout” in Chapter “System Settings”) and select whether values only or values and intermediate values are printed.

Example: Intermediate value output      02 : 00      8 . 16 %M

### Output Format

The characters are printed with the header. No more than 22 characters can be displayed in one line. Longer character sets are printed out on two lines. The printout is set to justified alignment. The following characters and abbreviations are used:

- Space \_ A space is indicated with an underscore: \_
- Carriage Return CR A carriage return (or line break) is abbreviated with "CR."
- Line Feed LF A line feed is abbreviated with "LF."

#### Example 1

The first example has a 6-character header (columns 1 to 6) and can therefore be printed in one line. Column 7 is used for signs before values (+, -). Values are given in columns 8 to 16 with decimal points or text. The unit characters are given in columns 17 to 20.

If the unit "%M/S" is selected, use four characters to print out the units because no space is printed before a unit. In a print interval, however, one line is generated with the following:

- Five characters for a header
- One character for a space
- Nine characters for the values including signs
- One space
- Four characters for the units

1	2	3	4	5	6	7	8	9	10	11	12	13	14	15	16	17	18	19	20	21	22
N	_	_	_	_	_	+	_	_	_	_	6	7	.	8	7	_	g	_	_	CR	LF
M	o	i	s	t	_	+	_	_	_	_	_	_	2	2	_	%	M	_	CR	LF	
1	0	:	2	3	_	+	_	_	_	_	0	.	2	3	_	%	M	/	S	CR	LF

#### Example 2

The second example has a longer header (columns 1 to 7) and can therefore be printed in one line:

1	2	3	4	5	6	7	8	9	10	11	12	13	14	15	16	17	18	19	20	21	22
D	e	v	_	_	_	+	_	_	_	5	6	7	.	8	7	_	g	_	_	CR	LF
S	t	a	n	d	b	y	_	_	_	_	_	_	_	_	0	f	f	_	CR	LF	

#### Example 3

The third example requires more than 22 characters and must therefore be printed on two lines:

1	2	3	4	5	6	7	8	9	10	11	12	13	14	15	16	17	18	19	20	21	22
D	i	s	p	l	a	y	e	d	_	r	e	s	u	l	t	_	_	_		CR	LF
_	M	o	i	s	t	u	r	e	_	c	o	n	t	_	i	n	_	%	M	CR	LF

## Error Messages

Certain events cause a message to appear on the display:

1. Some error messages are displayed for approx. 3 seconds (e.g., **CAL-Extern**: calibration canceled).
2. Some error messages are displayed until they are acknowledged by pressing a key (e.g., “Incorrect access code” in “Service access”).
3. Information messages are displayed until they are acknowledged by pressing a key.

### Deactivated Keys

To prevent operating errors, only relevant functions/keys are displayed depending on the situation. This prevents most operating errors from occurring. The following buttons are only available in specific circumstances:

·O·	Only if there is a measured value in the zero setting range before external calibration/adjustment.
·T·	Only if there is a measured value larger or smaller than “zero.”

### Error Messages during Operation

“Value is too small.”	When an entered value is too low for the parameter.
“Value is too large.”	When an entered value is too high for the parameter.
Error 46	When the max. heating temperature has been briefly exceeded.
Error 401 to 407	Faulty heating element. Contact the Sartorius Service Center.

### Calibration/Adjustment Error Messages

“Weight is too low.”	When a weight that is too light is placed during external calibration.
“Weight is too high.”	When a weight that is too heavy is placed during external calibration.
“Not able to save cal. data.”	When the memory is full.

### Information about Analyzer Maintenance

“Maintenance interval expired.”	When the maintenance date set by the Sartorius Service Center has been exceeded.
---------------------------------	--

### USB Device Error Message

“The attached USB device is not supported.”	When a USB device (printer) that is not permitted by Sartorius has been connected.
---	--

### Problems

Problem/Meaning	Remedy
Selected temperature is too high and the sample is oxidized; sample is boiling or burning and the splashes are continuously changing the weight.	<ul style="list-style-type: none"> <li>– Reduce drying temperature</li> <li>– Lay glass-fiber filter onto the sample</li> <li>– Reduce the sample quantity or apply the sample more evenly</li> <li>– Select a semi-automatic switch-off criterion or select timer mode</li> </ul>
Measurement time too long	<ul style="list-style-type: none"> <li>– Increase temperature</li> <li>– Reduce sample quantity</li> <li>– Preheat the analyzer by running a drying process for 2 or 3 minutes with an empty sample pan, for example</li> </ul>
Sample loses weight before it is analyzed	<ul style="list-style-type: none"> <li>– Remove the sample pan and apply the sample outside the analyzer</li> </ul>
Sample is liquid or pasty	<ul style="list-style-type: none"> <li>– Use glass fiber filter</li> </ul>
Sample has only a low moisture content	<ul style="list-style-type: none"> <li>– Increase sample quantity</li> </ul>
Insufficient heating output	<ul style="list-style-type: none"> <li>– Clean temperature sensor</li> </ul>
Place of installation unstable (vibrations, etc.)	<ul style="list-style-type: none"> <li>– Set up the scale in another area</li> </ul>

## Shipping the Analyzer

Please use the original packaging for shipping.  
You can order packaging from the Sartorius Service Center if necessary.



Avoid shocks and vibrations.



**Prior to shipping, switch the analyzer to standby mode (see page 20) and then pull the plug.**

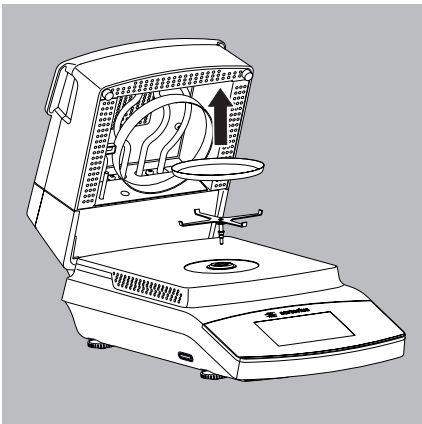

- ▶ Remove the following parts from the analyzer:
  - Disposable sample pan
  - Pan support

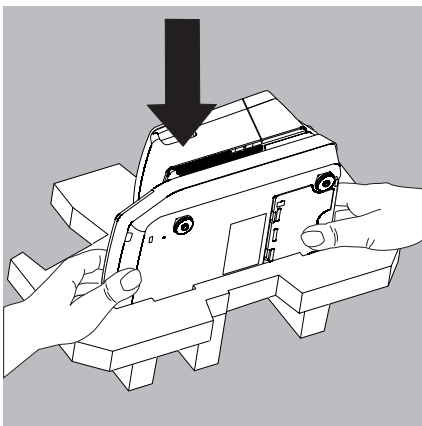

- ▶ Place the analyzer in one side of the packaging.

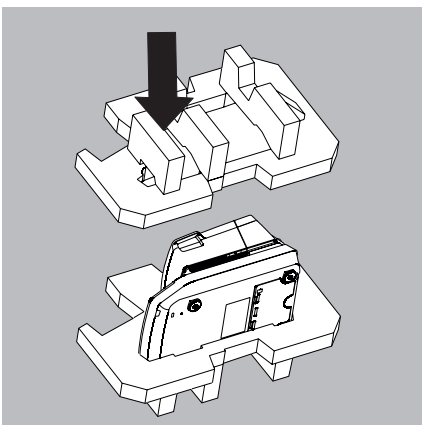

- ▶ Place the other side of the packaging over the analyzer:

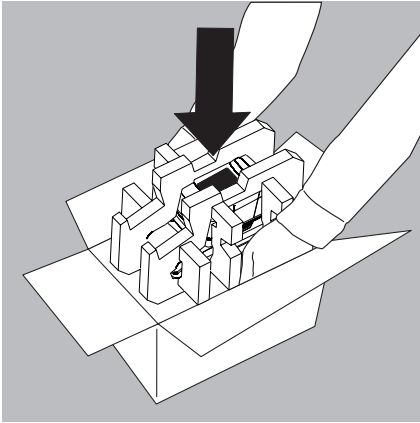

- ▶ Then put the packaged analyzer into the cardboard box and seal the box.



# Care and Maintenance

## Service

To ensure its continued weighing accuracy, we recommend performing regular servicing on your analyzer at least once a year. The Sartorius Service Center offers different service contracts for this purpose, which can be individually adapted to suit your needs (see also [www.sartorius.com/service](http://www.sartorius.com/service)). Each service produces a calibration certificate. The analyzer and its connections must undergo a technical safety inspection on a regular basis carried out by an electrician (e.g., every 2 years).



## Repairs

Repair work must only be carried out by trained service technicians. The analyzer must be unplugged during repair work. Unplug the power cable from the socket. Failure to do so may affect the measurement accuracy of your analyzer and pose a serious risk to the user. Contact the Sartorius Service Center or a Sartorius dealer to arrange for proper repairs.

## Cleaning the Analyzer

### Cleaning the Control Panel

Switch the display to standby mode to avoid modifying the settings for operation during cleaning.



- ▶ Select the menu key to switch to the method menu.



- ▶ If you then select , the display is switched off.



- ▶ To switch the display back on: Select  at the bottom left of the display. The moisture analyzer starts in the application most recently used before the analyzer was last switched off.

### Cleaning the Housing



Disconnect the analyzer from the power before cleaning. Disconnect any data cables from the moisture analyzer.



Never open the analyzer housing. The parts contained in the housing cannot be cleaned, repaired, or replaced by the operator.

- Make sure that no liquid or dust gets into the analyzer.
- Remove the disposable sample pan and pan support from the analyzer.
- Never use cleaning agents that contain solvents or abrasive ingredients, which can ultimately damage the equipment.
- ▶ Clean the outside of the housing with a lint-free cloth and mild cleaning agent (e.g., isopropanol).
- ▶ Then dry the analyzer with a soft cloth.



**Contaminated Equipment:**

- Health risk from product contamination due to product deposits and the collection of residue with microbial contamination.
- Health risk from biological or microbiological substances.
- Observe cleaning specifications.
- Check the cleaning result closely.

**Cleaning the Heating Module**



**Danger of Burns:**

The inner part of the heating module and parts of the sample chamber may be extremely hot.

Wait until the heating module has cooled completely.



Avoid touching the heating element. To remove spray residues or deposits from the heating element, use a weak solvent such as ethanol.

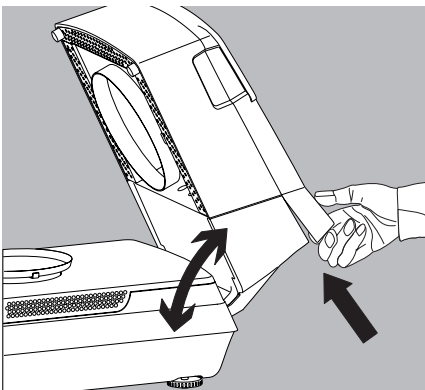

**Unlocking the Heating Module**

- 1) Open the heating module all the way.
- 2) Pull the unlocking handle at the back of the heating element to unlock the heating element.

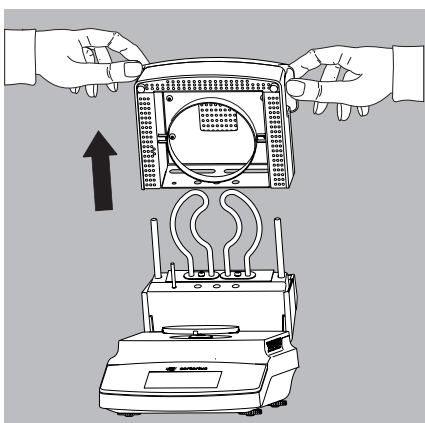

**Removing the Heating Module**

- 3) Pull the heating module up out of the guide.

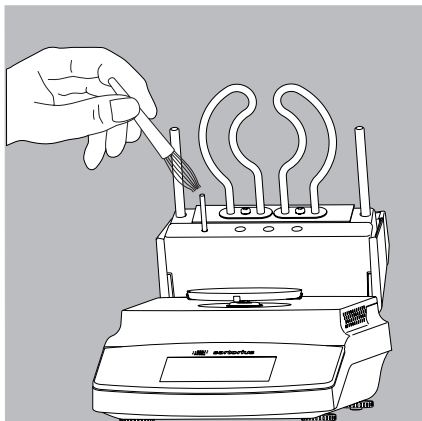

- 4) Clean the heating element and temperature sensor with a weak solvent such as ethanol.

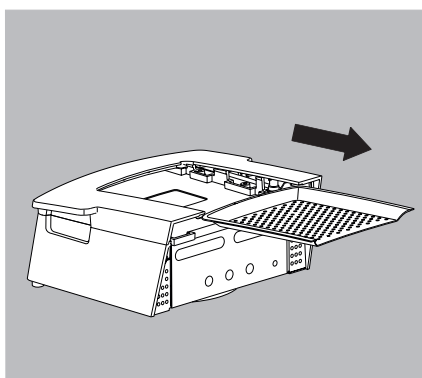

- 5) If necessary, pull the air extractor grate out of the heating module. Then clean the heating module and grate in a dishwasher.
- 6) Once cleaning is complete, reassemble the heating module and reinstall in the analyzer, following the instructions in reverse order. The heating module must snap into place on the analyzer.

### Cleaning the Bottom of the Sample Chamber



#### **Danger of Burns:**

Parts of the sample chamber may be extremely hot.  
Wait until the bottom of the sample chamber has cooled completely.

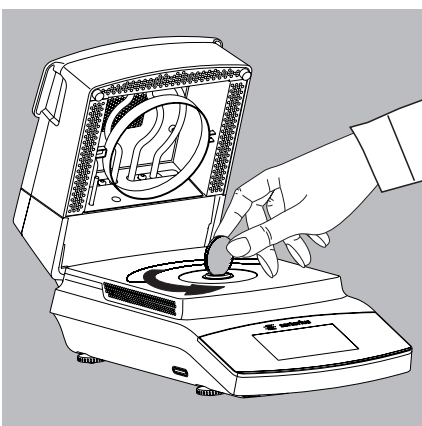

#### **Removing the Sample Chamber Bottom**

- 1) Unlock the “Locking socket (bayonet)” as in general view with a suitable coin.

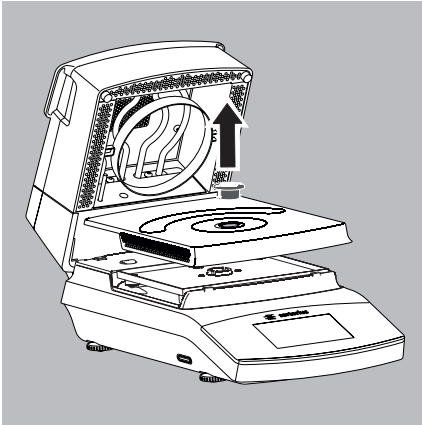

- 2) Remove the “Locking socket (bayonet)” as in general view and sample chamber bottom from the analyzer and clean in a dishwasher.
- 3) After cleaning, fix the sample chamber bottom into place again on the analyzer using the “Locking socket (bayonet)” as in general view.

## Disposal



The packaging is made of environmentally friendly materials that can be used as secondary raw materials. If you no longer require the packaging, you can dispose of it free of charge in Germany through the Vfw dual system (contract number D-59101-2009-1129). Otherwise you should dispose of the material in accordance with the waste disposal regulations that are applicable in your area. The equipment, including accessories and batteries, does not belong in your regular household waste. The EU legislation requires its Member States to collect electrical and electronic equipment and dispose of it separately from other unsorted municipal waste with the aim of recycling it. For more information regarding disposal and recycling, please contact our local service representatives. Our partners listed on the following website will also be able to provide assistance within the EU:

- 1) Go to <http://www.sartorius.com/de>.
- 2) Select the “Service” menu item.
- 3) Then select “Information on Disposal.”
- 4) Addresses for the local Sartorius disposal contacts can be found in the PDF files available for download on this page.



Sartorius will not take back equipment contaminated with hazardous materials (ABC contamination) – either for repair or disposal.

### **Service Address Disposal:**

Please refer to our website ([www.sartorius.com](http://www.sartorius.com)) or contact the Sartorius Service Center for more detailed information regarding repair service addresses or the disposal of your device.

# Specifications

<b>Dryer Functions</b>		<b>MA37-1</b>
Temperature range and settings	40°C–160°C, in increments of 1°C; stand-by temperature selectable from 40–100°C	
Sample heating	Infrared heating using a metal tube heater	
Heating programs	Standard drying, gentle drying	
Switch-off criterion	Optional: – Fully automatic – Semi-automatic mg (1–50 mg/5–300 s) – Semi-automatic % (0.1–5.0%/5–300 s) – Time (2:00–99.59 min.) – Manual	
Displayed result	Moisture in %M and g; dry weight in %S and g; ATRO in %M/S	
Net weight, approx.	6.3 kg	
<b>Weighing Functions</b>		
Max. weighing capacity	70 g	
Repeatability, average	For initial sample weight approx. > 1 g: ± 0.2% For initial sample weight approx. > 5 g: ± 0.05%	
Readability	1 mg; 0.01%	
Typical sample quantity	5 to 15 g	
External calibration weight	50 g (E2)	
Disposable sample pan dimensions	Ø 90 mm	
Interface	Mini USB: Automatic detection of Sartorius printers YDP30 and YDP40, direct data transfer to Microsoft® Windows programs without additional software, programmable data output interval	
<b>Power Supply</b>		
Input supply voltage	100–120 V AC and 210–240 V AC (automatic voltage detection), ±10%, 50/60 Hz	
Protection class and standards	Protection class I as per EN 61010-1/IEC 61010-1; up to 3000 m above sea level; IP20 as per EN 60529/IEC 60529	
Power supply	Using country-specific power cable from Sartorius only	
Power consumption	Max. 640 W (typically)	
<b>Ambient Conditions</b>		
The specifications are valid for the following ambient conditions:		
Environment	For indoor use only	
Ambient temperature	+10°C to +30°C	
Operating temperature	Operation guaranteed between +5°C and +40°C	
Storage and shipping	–10°C to +60°C	
Height	Up to 3000 m above sea level	
Relative humidity	15% to 80% for temperatures up to 31°C non-condensing, decreasing linearly up to 50% relative humidity at 40°C and 20% at 50°C	
<b>Safety of Electrical Equipment</b>		
		As per EN 61010-1/IEC 61010-1 Safety requirements for electrical equipment for measurement, control, and laboratory use – Part 1: General requirements
<b>Electromagnetic Compatibility</b>		
		As per EN 61326-1/IEC 61326-1 Electrical equipment for measurement, control, and laboratory use – EMC requirements – Part 1: General requirements
Defined immunity to interference:	Suitable for use in industrial areas	
Limitation of emissions:	Class B [suitable for use in residential areas and areas that are connected to a low voltage network that (also) supplies residential buildings]. Therefore, the analyzer can be used in both areas.	

## Accessories

Item	Order no.
Disposable sample pans, 80 pcs., aluminum, Ø 90 mm	6965542
Glass-fiber pad for analysis of pasty and fatty samples, hard quality, 80 pcs., Ø 90 mm	6906940
Glass-fiber pad for analysis of liquid and fatty samples, soft quality, 200 pcs., Ø 90 mm	6906941
External adjustment weight: – 50 g, OIML class E2, with DKD certificate	YCW452-AC-02
Tweezers	69MA0072
<b>Printers and Communication</b>	
Premium GLP lab printer	YDP30
– Printer paper for GLP lab printer paper	69Y03285
– Continuous labels for GLP lab printer	69Y03286
Data cable for Mini USB/USB A	YCC04-D09
Data cable for Mini USB/9-pin RS-232	YCC03-D09
<b>Spare Parts</b>	
Protective cover for the control panel	Upon request
Sample tongs	Upon request

# Analyzer Dimensions

## MA37

All dimensions are given in millimeters

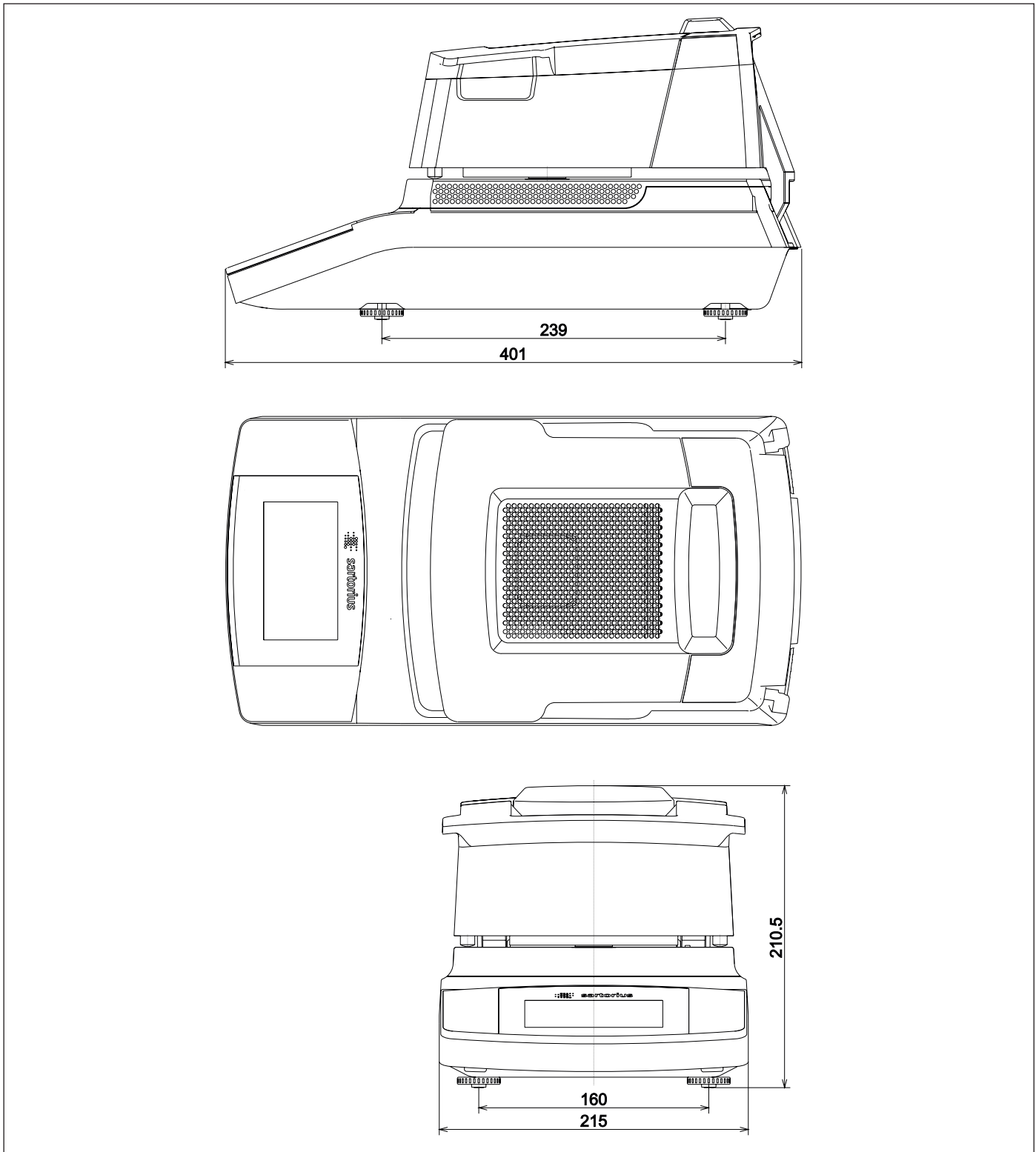





## EG-/EU-Konformitätserklärung EC / EU Declaration of Conformity



**sartorius**

**Hersteller**  
*Manufacturer* Sartorius Lab Instruments GmbH & Co. KG  
Weender Landstrasse 94 – 108, D-37075 Goettingen, Germany

erklärt in alleiniger Verantwortung, dass das Betriebsmittel  
*declares under sole responsibility that the equipment*

**Geräteart**  
*Device type* Feuchtebestimmer  
*Moisture analyzer*

**Baureihe**  
*Type series* MA37-1, MA160-1

in der von uns in Verkehr gebrachten Ausführung mit den grundlegenden Anforderungen der folgenden Europäischen Richtlinien übereinstimmt und die anwendbaren Anforderungen folgender harmonisierter Europäischer Normen erfüllt:

*in the form as delivered complies with the essential requirements of the following European Directives and meets the applicable requirements of the harmonized European Standards listed below:*

2004/108/EG  
2004/108/EC

Elektromagnetische Verträglichkeit  
*Electromagnetic compatibility*

EN 61326-1:2013

Elektrische Mess-, Steuer-, Regel- und Laborgeräte – EMV- Anforderungen – Teil 1: Allgemeine Anforderungen

*Electrical equipment for measurement, control and laboratory use – EMC requirements – Part 1: General requirements*

2006/95/EG  
2006/95/EC

Elektrische Betriebsmittel zur Verwendung innerhalb bestimmter Spannungsgrenzen  
*Electrical equipment designed for use within certain voltage limits*

EN 61010-1:2010

Sicherheitsbestimmungen für elektrische Mess-, Steuer-, Regel- und Laborgeräte – Teil 1: Allgemeine Anforderungen  
*Safety requirements for electrical equipment for measurement, control, and laboratory use – Part 1: General requirements*

2011/65/EU  
2011/65/EU

Beschränkung der Verwendung bestimmter gefährlicher Stoffe in Elektro- und Elektronikgeräten (RoHS)  
*Restriction of the use of certain hazardous substances in electrical and electronic equipment (RoHS)*

EN 50581:2012

Technische Dokumentation zur Beurteilung von Elektro- und Elektronikgeräten hinsichtlich der Beschränkung gefährlicher Stoffe

*Technical documentation for the assessment of electrical and electronic products with respect to the restriction of hazardous substances*

Jahreszahl der CE-Kennzeichenvergabe | *Year of the CE mark assignment:* 14

Sartorius Lab Instruments GmbH & Co. KG  
Goettingen, 2014-05-28

*i.v. P. Baumfalk*

Dr. Reinhard Baumfalk  
Vice President R&D

*i.v. D. Klausgrete*

Dr. Dieter Klausgrete  
Head of International Certification Management

Diese Erklärung bescheinigt die Übereinstimmung mit den genannten EG- und EU-Richtlinien, ist jedoch keine Zusicherung von Eigenschaften. Bei einer mit uns nicht abgestimmten Änderung des Produktes verliert diese Erklärung ihre Gültigkeit. Die Sicherheitshinweise der zugehörigen Produktdokumentation sind zu beachten.

*This declaration certifies conformity with the above mentioned EC and EU Directives, but does not guarantee product attributes. Unauthorised product modifications make this declaration invalid. The safety information in the associated product documentation must be observed.*

Doc: 2018085

SLI14CE019-00.de,en

1 / 1

PMF: 2018082

OP-113-fo1



# Certificate of Compliance

**Certificate:** 70006866

**Master Contract:** 167555

**Project:** 70006866

**Date Issued:** August 6, 2014

**Issued to:** Sartorius Lab Instruments  
GmbH & Co. KG  
94-108 Weender Landstrasse  
Goettingen, 37075  
Germany

*The products listed below are eligible to bear the CSA Mark shown with adjacent indicators 'C' and 'US' for Canada and US or with adjacent indicator 'US' for US only or without either indicator for Canada only.*



*Francois Gregoire*

**Issued by:** Francois Gregoire

## **PRODUCTS**

**CLASS 8721 05** - LABORATORY EQUIPMENT - Electrical

**CLASS 8721 85** - ELECTRICAL EQUIPMENT FOR LABORATORY USE - Certified to US Standards

Moisture Analyzers, Models MA37 and MA160, Rated 100-120Vac / 210-240Vac, 50/60Hz, 640W (max).

## Notes:

1. The above models are cord connected, Equipment Class I, Pollution Degree 2, Installation Category II.
2. Mode of operation: Continuous
3. Environmental Conditions:
  - Operating Temperature: 5 to 40°C;
  - Indoor use only;
  - Altitude: 3000 m max;
  - Relative humidity 15% to 80% for temperatures up to 31°C non-condensing, decreasing linearly up to 50% relative humidity at 40°C;



**Certificate:** 70006866

**Master Contract:** 167555

**Project:** 70006866

**Date Issued:** August 6, 2014

- +/- 10% mains supply fluctuations
4. The MA37 and MA160 include different models designation codes. The model designation code is MA37-x-yyyy and MA160-x-yyyy. Where x and y represent non safety relevant information as listed below:
- "x" is a number (1,2,3,...) and denotes the version (e.g. 1);
  - "yyyy" may be up to four numbers and/or letters or blank and denote special versions like country of destination, special software.

#### **APPLICABLE REQUIREMENTS**

CAN/CSA-C22.2 No. 61010-1-04 - Safety Requirements for Electrical Equipment for Measurement, Control, and Laboratory Use, Part 1: General Requirements

CAN/CSA C22.2 No. 61010-2-010:04 - Particular requirements for laboratory equipment for heating of materials

UL Std. No. 61010-1 (2nd Edition) - Safety Requirements for Electrical Equipment for Measurement, Control, and Laboratory Use - Part 1: General Requirements

IEC 61010-2-010-2003 (2nd Edition) - Particular requirements for laboratory equipment for heating of materials

#### **CONDITIONS OF ACCEPTABILITY**

(1) The main supply cord set provided with the equipment must be an approved type acceptable to the authorities in the country where the equipment is sold. It is the manufacturer's responsibility to provide a detachable power supply cord compliant with the requirements of sub-clause 6.10.1 and that is suitable for the country of usage and compliant to local regulations and electrical codes. A power supply cord description is provided in the List of critical components. The power supply cord shall include a protective earth wire and shall be positioning so that it cannot touch the hot surfaces of the analyzer.

(2) Intended Use: The moisture analyzer can be used for determination of the moisture content of materials of liquid, pasty, and solid substances using the thermogravimetric method. The analyzer shall be use only for this purpose. Any other use outside the limits of the technical specifications is not permitted.

(3) The analyzer must not be operated in potentially explosive atmospheres. Unit is not intended to be used with flammable liquids or materials. Materials or liquids liable to catch fire or explode shall not be used as samples for moisture analysis.

(4) Appropriate containers must be used for each type of sample material.



**Certificate:** 70006866

**Master Contract:** 167555

**Project:** 70006866

**Date Issued:** August 6, 2014

- 
- (5) If use with substances that contains poisonous or caustic ingredients, the equipment must be use under a laboratory hood.
- (6) Do not put any flammable substances on, under, or near the moisture analyzer. Minimum clearance spacing required on final installation:
- 1 m above the analyzer
  - 20 cm around the analyzer
- (7) When operating the analyzer, suitable protective equipment must be worn in order to minimize dangers to health.
- (8) Moisture analysis applications must be optimized by the user in accordance with local regulations. If at any time there is a conflict between the system safety provisions and any relevant local (national or regional) requirements, the local requirements always take precedence.

Sartorius Lab Instruments GmbH & Co. KG  
Weender Landstrasse 94–108  
37075 Goettingen, Germany

[www.sartorius.com](http://www.sartorius.com)

Copyright by Sartorius, Goettingen,  
Germany.

No part of this publication may be  
reprinted or translated in any form or by  
any means without prior written permis-  
sion from Sartorius. All rights reserved by  
Sartorius in accordance with copyright law.

The information and figures contained  
in these instructions correspond to the  
version date specified below. Sartorius  
reserves the right to make changes to the  
technology, features, specifications and  
design of the equipment without notice.

Status:

October 2014,  
Sartorius Lab Instruments GmbH & Co. KG,  
Goettingen